



Instruction Manual & Safety Warnings

Combination Primary and Backup Sump Pump System Model PS-C22

PAIR OF PUMPS



Table of Contents

Important Safety Warnings and Instructions

| | |
|------------------------|---|
| Electrical precautions | 2 |
| Battery preparation | 2 |
| Battery precautions | 2 |

Introduction

| | |
|--------------------------|---|
| Items included in system | 3 |
| Additional items needed | 3 |
| System specifications | 3 |

Installing the Pipe and Pump

| | |
|----------------------|---|
| Battery Instructions | 5 |
|----------------------|---|

System Connections

| | |
|-----------------------------|---|
| Connecting the backup pump | 5 |
| Connecting the battery | 5 |
| Connecting two batteries | 5 |
| Connecting the charger | 5 |
| Connecting the primary pump | 5 |

Product Operation

| | |
|---|---|
| Understanding the Warning Lights and Alarms | 6 |
|---|---|

| | |
|---|---|
| Silencing the alarm during an emergency | 6 |
| Cleaning battery terminals | 7 |
| Replacing the battery | 7 |
| Fuse alarm | 8 |
| Backup pump activated | 8 |

| | |
|----------------------------|------|
| Replacing the backup pump | 8 |
| Replacing the primary pump | 9,10 |
| Power alarm | 11 |
| Charging | 11 |
| System operating | 11 |

Testing the System

| | |
|----------------------------------|----|
| Test-Reset-Silence button | 11 |
| Testing the backup float switch | 11 |
| Testing the primary float switch | 11 |

Using the Remote Notification

| | |
|-----------------|----|
| Remote Terminal | 12 |
| Remote Alarm | 12 |

USB Data Port

| | |
|----------------|----|
| CONNECT Module | 12 |
|----------------|----|

Maintenance Checklist

| | |
|-----------------------------|----|
| Parts & Service Information | 12 |
| Technical support | 12 |

Replacement Parts List & Diagram

| | |
|-----------------------|----|
| Troubleshooting Guide | 14 |
|-----------------------|----|

| | |
|----------|----|
| Warranty | 15 |
|----------|----|

| | |
|----------------|----|
| Other Products | 16 |
|----------------|----|



Scan the QR code for more information about the PS-C22 Combination Sump Pump System

IMPORTANT: Even if you have the Pro Series™ PS-C22 Combination Sump Pump System installed by someone else, you must read and follow the safety information contained in this manual. Failure to do so could result in property damage, serious injury, or death.

Important Safety Warnings & Instructions

SAVE THESE INSTRUCTIONS. This manual contains important SAFETY WARNINGS and OPERATING INSTRUCTIONS for the Pro Series™ combination sump pump system. You will need to refer to it before attempting any installation or maintenance. **ALWAYS** keep these instructions with the unit so that they will be easily accessible.

Failure to read and follow these warnings and instructions could result in property damage, serious injury, or death. It is important to read this manual, even if you did not install the Pro Series combination sump pump system, since this manual contains safety information regarding the use and maintenance of this product. **DO NOT DISCARD THIS MANUAL.**

ELECTRICAL PRECAUTIONS

⚠ WARNING

This installation must be in accordance with the National Electric Code and all applicable local codes and ordinances.

⚠ DANGER

Risk of electrical shock and fire hazard. May result in death, serious injury, shock or burns. To help reduce these risks, observe the following precautions:

- **DO NOT** walk on wet areas of the basement until all power has been turned off. If the main power supply is in a wet basement, call an electrician.
- **NEVER** handle the control unit with wet hands or while standing on a wet surface.
- **ALWAYS** unplug the control unit and disconnect the cables from the battery before attempting any maintenance or cleaning.
- **ALWAYS** unplug the main pump when installing or servicing the backup pump or float switch to avoid electric shock.
- **DO NOT** expose the control unit to water, rain or snow. **DO NOT** place the control unit on the floor.
- **DO NOT** pull the cord when disconnecting the control unit. Pull the plug.
- **DO NOT** pull on the float switch cord.

- **MAKE SURE A PROPERLY GROUNDED RECEPTACLE IS AVAILABLE.** This pump is wired with a 3-prong grounded plug. To reduce the risk of electrical shock, be certain that it is only connected to a properly grounded 3-prong receptacle. If you have a 2-prong receptacle, have a licensed electrician replace it with a 3-prong receptacle according to local codes and ordinances.
- **DO NOT** use an extension cord. The electrical outlet should be within the length of the control unit's power cord, and at least 4 feet above the floor.
- **DO NOT** use an attachment not recommended or sold by the manufacturer. It may result in a risk of fire or injury from an electrical shock.
- **DO NOT** operate the computer control unit if it has received a sharp blow, been dropped, or otherwise damaged in any way.
- **DO NOT** disassemble the control unit.
- **DO** protect the electrical cord from sharp objects, hot surfaces, oil and chemicals. Avoid kinking the cord.
- **MAKE SURE** the supply circuit has a dedicated fuse or circuit breaker rated to handle the power requirements of this system.
- **DO NOT** use in pits handling raw sewage, salt water or other hazardous materials. This system for groundwater use only.

When service is required, contact Glentronics technical support at **800-991-0466**, or send an email to **service@glentronics.com**. Return the control unit to the manufacturer for any repairs at the following address:

Glentronics, Inc., Attn: Repairs
645 Heathrow Drive, Lincolnshire, IL 60069-4205

BATTERY PREPARATION

⚠ WARNING / POISON

Sulfuric acid can cause blindness or severe burns. Avoid contact with skin, eyes or clothing. In the event of accident, flush with water and call a physician immediately. KEEP OUT OF REACH OF CHILDREN.

To help reduce these risks, observe the following precautions:

- Someone should be within range of your

voice or close enough to come to your aid when you work near a lead-acid battery.

- Have plenty of fresh water and soap nearby in case battery acid contacts skin, clothing or eyes.
- Wear eye and clothing protection and avoid touching your eyes while working with battery acid or working near the battery.
- If battery acid contacts skin or clothing, wash immediately with soap and water. If acid enters eye, immediately flood eye with running cold water for at least 15 minutes and get medical attention.

⚠ WARNING: Battery posts and terminals contain lead, lead compounds or chemicals known to the State of California to cause cancer, birth defects or other reproductive harm. Wash hands after handling. See www.p65warnings.ca.gov for more information.

⚠ WARNING: Battery fluid can expose you to chemicals including strong inorganic acid mists containing sulfuric acid, which is known to the State of California to cause cancer. For more information go to www.P65warnings.ca.gov.

BATTERY PRECAUTIONS

⚠ DANGER

Explosive gases could cause serious injury or death. Cigarettes, flames or sparks could cause battery to explode in enclosed spaces. Charge in well-ventilated area. Always shield eyes and face from battery. Keep vent caps tight and level.

To help reduce these risks, observe the following precautions:

- **NEVER** smoke or allow a spark or flame in the vicinity of the battery.
- Use the Pro Series control unit for charging a LEAD-ACID battery only. **DO NOT** use the control unit for charging dry-cell batteries that are most commonly used with home appliances.
- Be sure the area around the battery is well-ventilated.
- When cleaning or adding water to the battery, first fan the top of the battery with a piece of cardboard or another nonmetallic material to blow away any hydrogen or

oxygen gas that may have been emitted from the battery.

- **DO NOT** drop a metal tool onto the battery. It might spark or short-circuit the battery and cause an explosion.
- Remove personal metal items such as rings, bracelets, watches, etc. when working with a lead-acid battery. A short circuit through one of these items can melt it, causing a severe burn.
- **ALWAYS** remove the charger from the electrical outlet before connecting or disconnecting the battery cables. Never allow the rings to touch each other.
- Check the polarity of the battery posts. The POSITIVE (+) battery post usually has a larger diameter than the NEGATIVE (-) post.

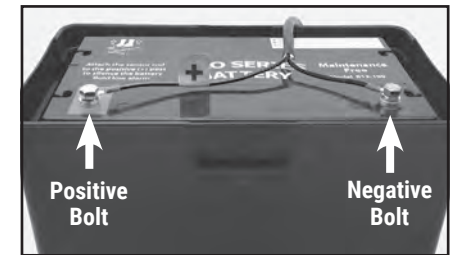

- When connecting the battery cables, first connect the large ring on the end of the RED wire to the POSITIVE (+) post and then connect the small ring on end of the BLACK wire to the NEGATIVE (-) post of the battery.
- **ALWAYS** keep the cover secured on the battery box by slipping the tabs through the fittings on the front and back of the box.

⚠ DANGER

Do not use system to pump flammable or explosive fluids such as gasoline, fuel oil, kerosene, etc.

DO NOT use this system in pits handling raw sewage or other hazardous liquids.

Introduction

The Pro Series pair of pumps combination system is designed to provide both primary and backup pumping capabilities. The primary pump will operate as long as it is receiving AC power. If the power is interrupted, or more water is coming into the sump than the AC pump can handle, the backup sump pump will begin pumping automatically. The backup system has unique monitoring features that diagnose a problem and sound an alarm. A light on the display panel of the control unit will indicate the cause of the alarm and the possible corrective action. The two systems have been preassembled for easy installation.

For added reliability, the float switches have not one but two floats. Should one float fail to operate, the second float will automatically activate the pump.

The Combination Sump Pump System includes:

- A ½ HP primary pump with a caged dual float switch, and a blue piggyback controller that plugs into the wall outlet
- A blue backup pump
- A backup control unit with a dual float switch, battery cables, and a 20-Amp fuse
- A battery charger
- A battery box
- A no-hub coupling

You will also need to supply:

- A Pro Series B12-100 standby battery

Pro Series standby batteries are specifically designed to work with your battery backup sump pump system. Glentronics cannot guarantee the compatibility of



other brands of batteries. For optimal performance the use of a Pro Series standby battery is highly recommended.

- **DO NOT** use an automotive battery with this system
- A surge protector (recommended for the backup controller)

For some installations you may need these additional items:

- 1½-inch rigid PVC pipe to connect to the existing plumbing
- A PVC pipe connector or a rubber union
- PVC pipe cleaner and cement



To connect two batteries you will need:

- Two (2) batteries of same type, age and capacity (so they will have equal power and charge properly). **DO NOT** use batteries of different types, ages or capacities.
- A set of battery cables with rings on both ends to connect the two batteries together (Model PJC, available from Glentronics, Inc.)
- Another battery box

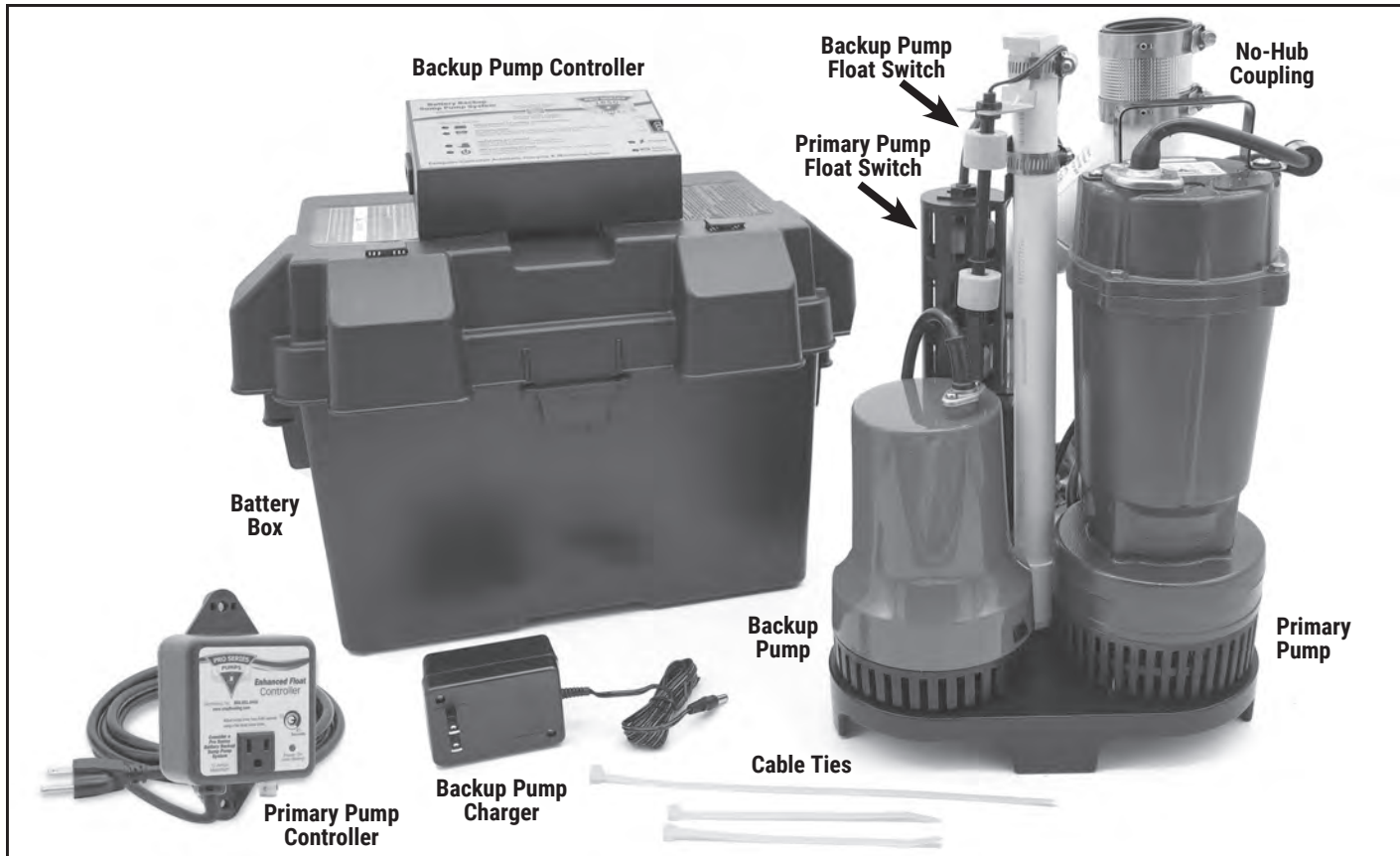

System Specifications

Power supply requirements 115 volts, 60 Hz
 AC pump pumping capacity... 2,770 GPH @ 10'
 46 GPM @ 10'
 DC pump pumping capacity... 1,850 GPH @ 10'
 31 GPM @ 10'
 Overall dimensions..... 9¼" W x 11" D x 17" H

Installing the Pipe and Pump

The Pro Series pair of pumps combination system is compact and will fit in a sump pit as small as 12-inches wide. It measures 15 $\frac{1}{2}$ inches from the bottom of the pump stand to the top of the wye connector where it will be attached to the discharge pipe.

Use a pit that conforms to all local codes, and check the code to see if a gate valve or ball valve is required.

The path of the existing vertical discharge pipe to an exterior wall should have the shortest path with the fewest turns. The more turns will reduce the pumping capacity. The horizontal discharge pipe must be positioned in a downward slope when it exits the building, so any remaining water will drain away. Failure to do this will prevent water from exiting the pit, and damage the pump if the line freezes. (See Diagram A)

The system should be placed on a flat surface free from dirt and debris. If the bottom of the

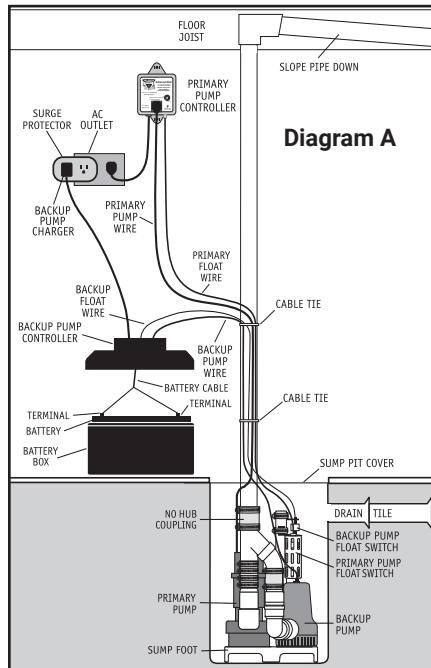

sump pit is not clean, remove as much of the debris as possible. The pumps are attached to a sump foot stand (SF2A) to raise them above any debris.

If you are replacing an old sump pump, **unplug the pump from the outlet.**

1. Remove the check valve or rubber union. **Discard the check valve. The Pro Series system contains built-in check valves, so the old check valve will not be needed.** If the existing system is installed without a check valve or rubber union, saw the pipe apart above the sump pit. (Refer to the diagram in step 3)
2. Remove the old pump from the pit, and unscrew the pipe and pipe adapter from the pump. You can use this pipe to extend the discharge pipe, if needed.
3. Measure the distance from the bottom of the sump pit to the end of the discharge pipe. Subtract 16 $\frac{1}{2}$ inches (the height of the pump system + 1 inch). Cut a piece of 1 $\frac{1}{2}$ -inch rigid PVC pipe to that length.
4. (a) Connect this piece to the discharge pipe by cementing the two pieces together with a 1 $\frac{1}{2}$ -inch PVC pipe connector (follow the instructions on the PVC pipe cleaner and cement). OR, (b) inserting a no-hub coupling.
5. Remove the attached cords and controllers from the carton and place them next to the pump system. **MAKE SURE THE CORDS AND CONTROLLERS DO NOT FALL INTO THE SUMP PIT.**
6. Loosen the hose clamps on the no-hub coupling and slide the coupling up on the discharge pipe. Tighten the upper hose clamp.
7. Inspect the two float switches. They should both be vertical.

8. Inspect all of the screws on the hose clamps of the no-hub couplings (primary and backup pumps). They should be tight.
9. Lift the combination system by the handle on the primary pump and lower it into the sump pit. Make sure it is level.
10. Position the top of the pump system pipe so that it is directly below the discharge pipe. Connect the system with the no-hub coupling, and tighten the upper and lower hose clamps. Make sure both the discharge pipe and the system have ample overlap within the no-hub coupling.

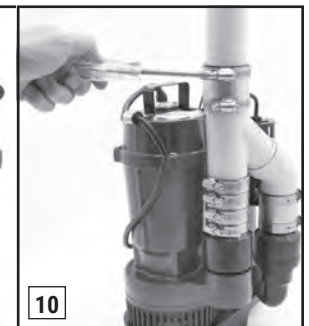
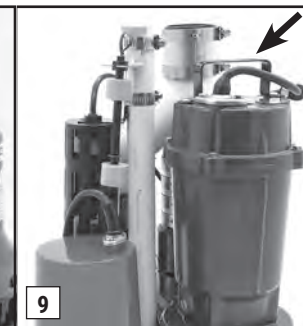
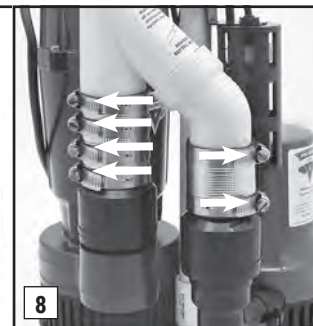
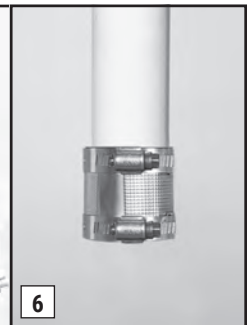
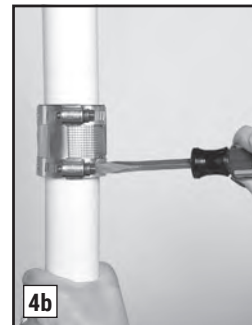
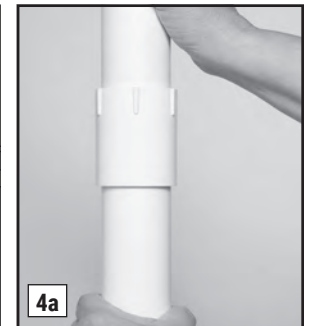
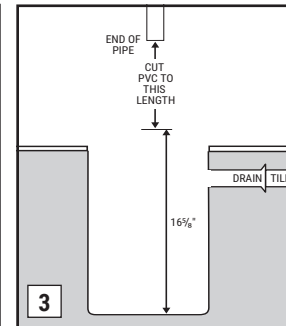
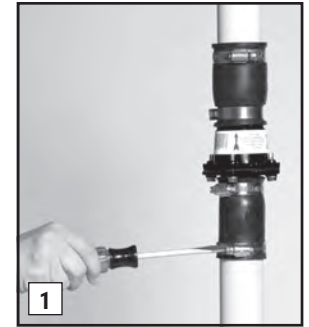

Battery Instructions

A Pro Series standby battery has been designed to run this system for 70 hours, based on a 10% duty cycle. However, most of the time the pump will turn on and off, and this battery will run the pump intermittently for days.

In addition, the unique materials in Pro Series batteries enable them to last longer in standby service.

Note: The battery will not run the primary pump.

CAUTION

- The use of automotive batteries is **NOT** recommended. Automotive batteries are not designed for this application. They will only run the pump for a short time and will have a shorter life than a standby battery.
- Pro Series standby batteries are specifically designed to work with your battery backup sump pump system. Glentronics cannot guarantee the compatibility of other brands of batteries. For optimal performance the use of a Pro Series standby battery is recommended.

System Connections

DANGER

Risk of electrical shock or battery explosion, which can cause serious injury or death. Wear eye protection. Work in a well-ventilated area. DO NOT smoke or allow a spark or flame in the vicinity of the battery. Avoid dropping metal tools on the battery. If battery acid contacts eyes, flush with water for 15 minutes. Review the safety instructions on page 2.

When you position the battery with the control unit on the top, be sure the charger cord will reach the AC power outlet, and the pump cable and the float switch will reach the bottom of the sump. Position the unit in a well-ventilated area. (Diagram C)

1. **Connecting the backup pump:** Remove the security tag from the pump and plug the pump wires into the pump connector on the back of the control unit.
2. **Connecting the battery:** Remove the bolts and washers from the plastic bag. Slip

the lock washer, washer, then the RED POSITIVE (+) wire ring over the bolt. Screw the bolt into the hole on the POSITIVE (+) terminal of the battery. Repeat for the NEGATIVE (-) terminal with the BLACK NEGATIVE wire.

3. **Connecting two batteries:** If you are connecting two batteries to the system, before you replace the bolts, connect the additional cable (Model PJC) to the two batteries—the POSITIVE wire to the POSITIVE (+) terminal and the NEGATIVE wire to the NEGATIVE (-) terminal of each battery. NEVER attach one end of the positive wire to the positive terminal and the other end of the positive wire to the negative terminal of the other battery.
4. **Connecting the charger:** (a) Immediately plug the charger into the charger hole on the back of the control unit, (b) then into an AC outlet on the wall. (Provide additional protection for the control unit by using a surge protector.)

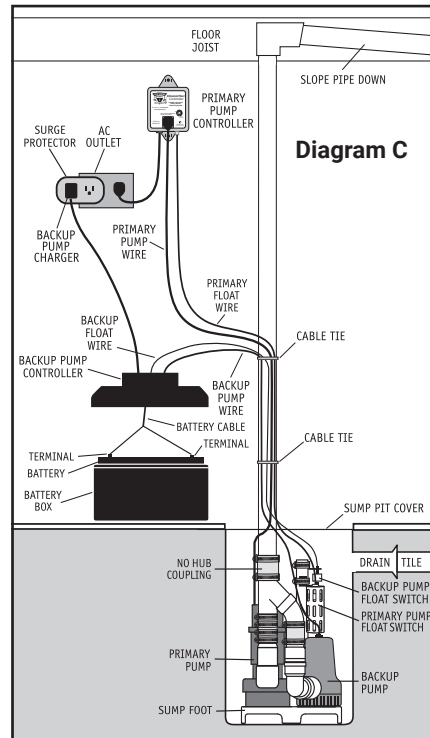

5. If any of the alarms are sounding, press the RESET button on the front of the control panel for one (1) second.
6. Secure the cover on the battery box by slipping the tabs through the fittings on the front and back of the box.
7. **Connecting the primary pump:** Mount the controller to the wall through the 2 holes on the cabinet using proper mounting hardware for the application. The controller should be mounted at least 4 inches from the floor and 1 inch from the outlet. Plug the controller into a properly grounded 3-prong outlet. Then plug the primary pump into the receptacle on the controller. Using a flathead screwdriver, adjust the dial on the front of the controller to select the number of seconds that the primary pump will run after the float drops. The dial can be adjusted from 5-45 seconds. The manufacturer default is about 10 seconds.
8. For a neater installation, secure the cables from the controllers to the discharge pipe in a couple places with additional cable ties. Make sure the wires are not touching or overlapping each other.
9. After the initial installation, be sure to check the pump operation by filling the sump with water and observing the pump

through several full cycles. The primary pump should run for 10 seconds after the lower float drops.

10. A pit cover is recommended for all installations as a safety measure and to prevent debris from falling into the pit. Place the cover on top of the pit making sure not to pinch or crimp the pump wires with the cover. The pit cover usually has an existing hole that will allow the cords to be passed through it, or you can drill a hole in the cover.

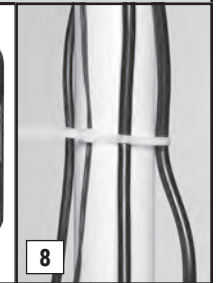
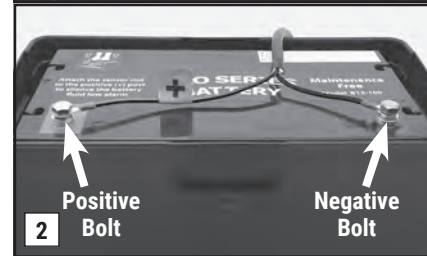
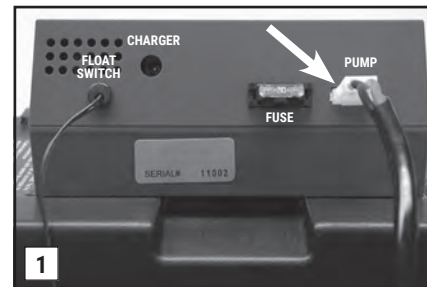
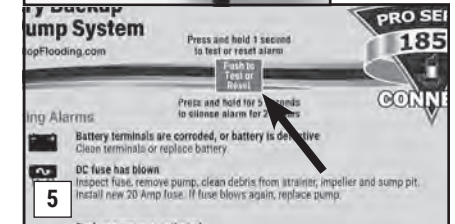
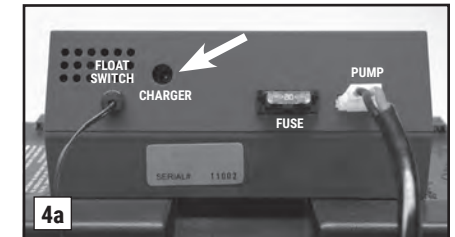

Product Operation

The dual float switch on the primary pump contains two large floating rings enclosed within a protective cage. Water will lift the bottom float by about ¼ inch, which will activate the pump. If for any reason the lower float does not activate the pump, the water will rise to the second float, and it will activate the pump. As the pump evacuates the water from the pit, the floats will drop. The pump will run for an additional 10 seconds to extend the cycle after the lower float drops. The primary float switch wire includes a connector that can be separated from the controller when the wire needs to be threaded through small openings. The float switch connector has a safety locking pin, which prevents the float switch from accidentally being disconnected from the controller. To remove the pin, push the pointed end of the pin into the float connector and pull it out from the other end. The float can now be disconnected from the controller. Make sure to reinstall the pin after the float is reconnected. The blue controller for the primary pump powers this switch.

During a power outage, or when more water is entering the sump than the primary pump can handle, the backup pump will automatically begin pumping. It also has a dual float switch, so if one float fails to activate the pump, the second float will activate the pump as soon as the water reaches that level. As the water recedes below the float switch, a timer in the control unit will run the pump an additional 25 seconds to empty the pit. The backup float switch wire includes a connector that can be separated from the controller when the wire needs to be threaded through small openings such as a sump pit cover. Be sure the float switch wire connection is secure before final installation.

While the pumps are active, water will come out of the 3/16" hole that is in the check valve above the pump. This is normal. The hole is needed to prevent an air lock within the system.

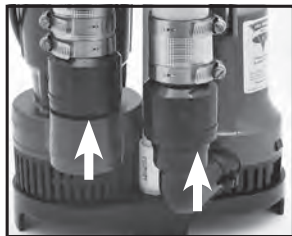

Do not obstruct this hole or an air lock may prevent the pump from activating, and the basement will flood.

Batteries and sump pumps need maintenance. The control unit on the backup system monitors the battery and power conditions, and sounds an alarm when maintenance is required. Following is an explanation of the warnings and alarms.

Understanding the Warnings Lights and Alarms

The Pro Series backup control unit features a series of warning lights that pinpoint potential problems. In addition, an alarm sounds to alert you to the problem. In some cases the lights and alarm will go off automatically when the problem has been solved. In others, the RESET button on the front of the control panel must be pushed to reset the alarm. Refer to the table below for a quick review of the features and their corresponding alarm status.

| Warning | Alarm can be silenced before problem is corrected | Alarm shuts off automatically when problem is corrected |
|--------------------|---|---|
| Battery problem | No | No, push RESET button |
| Fuse/pump problem | No | Yes |
| Pump was activated | Yes | No, must push RESET button |
| Power problem | Yes | Yes |

SILENCING THE ALARM DURING AN EMERGENCY

The Pro Series 1850 backup pump system allows you to silence some alarms during an emergency; however, the warning lights will stay on until the problem is corrected.

- Press the RESET button for one (1) second to reset the "Pump was activated" alarm, and silence the "AC power" alarm for two (2) minutes.

- Press the RESET button for five (5) seconds to silence these alarms for 24 hours. A brief buzzing sound will notify you that the alarms have been silenced. The alarms will automatically reactivate in 24 hours if the warning condition still exists.

1 Battery terminals are corroded, or battery is defective

This light and alarm will come on when the control unit detects that the battery has less than ½ hour of pumping power left, or that the battery is defective. The alarm cannot be silenced because action needs to be taken to protect your basement. If your battery is more than five (5) years old, replace it. If not, following are several situations that would cause the pump to run the battery for an extended time and discharge the battery. Check the following list before you replace the battery:

- If the bottom light on the controller is also on, it means that the unit is not receiving AC power. Either the AC power is out, the circuit breaker has blown, the outlet is bad, or the AC adapter is bad. When the problem is corrected, the battery should recharge.
- If the third light on the controller is also on, check your main pump for failure. The backup pump may have been activated

repeatedly if your main AC pump is broken, or you are experiencing heavy rains and your main pump cannot keep up with the inflow of water. You may need to upgrade or replace your main pump. When the problem is corrected, the battery should recharge.

- If no other lights are on, this means the terminals may be corroded, and the battery cannot charge properly. Unplug the charger from the wall outlet. Then, check the battery cables and the battery terminals for corrosion. Clean and tighten them as needed. The procedure is described on page 7.
- If the battery terminals have been cleaned and the light is still on, the problem could be with the controller or the battery. The best way to determine if the battery is the issue is to have it charged and load tested at a local automotive service station, auto parts or battery store. If the battery is bad and less than one (1) year old, it can be returned to the place of purchase for a replacement (receipt required). If the battery is good, contact Glentronics' service department for further instructions. The phone number is 800-991-0466.
- If the battery alarm goes on while the pump is running and the power is out, you will have a minimum of one-half (½) hour of continuous pumping time to replace the

Battery Backup Sump Pump System

www.StopFlooding.com











Press and hold 1 second to test or reset alarm

Push to Test or Reset

Press and hold for 5 seconds to silence alarm for 24 hours

Warning Alarms

- 1   **Battery terminals are corroded, or battery is defective**
Clean terminals or replace battery.
- 2   **DC fuse has blown**
Inspect fuse, remove pump, clean debris from strainer, impeller and sump pit. Install new 20 Amp fuse. If fuse blows again, replace pump.
- 3   **Backup pump was activated**
Check AC pump and its float switch for failure. See manual on website for other possible causes.
- 4   **Unit is not receiving AC power**
Check circuit breaker and GFI outlet, verify charger is plugged in on both ends, or replace charger.



Remote Connection



N.O.

N.C.

Common

Computer-Controlled Automatic Charging & Monitoring System

5   **Charging**

6   **System Operating**

battery. (In most cases, the pump does not run continuously, and therefore, you actually have a longer time to replace it.) You will not be able to silence the alarm. Left unattended, the basement will flood. In a severe emergency, if a replacement battery is not available, you could temporarily use your car battery, or recharge this battery by connecting it to your car battery.

- Once AC power is restored, the battery will recharge automatically, unless it is old or damaged. The alarm will remain on until the RESET button on the front panel of the control unit is pressed for one (1) second.
- In the event that your Pro Series sump pump system has pumped for an extended period of time, the battery may be very depleted. In this condition, when the AC power is returned to the unit, a battery alarm will continue to sound. The battery may need a longer period to recharge.
- For a faster recharge, an automotive or marine battery charger can be used to recharge the battery. Follow the manufacturer's instructions and safety information included with the charger.

⚠ WARNING

When another charger is used, first disconnect the Pro Series charger from the control unit, and then disconnect the control unit from the battery. Using another charger without disconnecting the control unit will destroy the control unit and void the warranty.

CLEANING THE BATTERY TERMINALS AND CABLES

⚠ DANGER

Risk of electrical shock or battery explosion, which can cause serious injury or death. Wear eye protection. Work in a well-ventilated area. Do not smoke or allow a spark or flame in the vicinity of the battery. Avoid dropping metal tools on the battery. If battery acid contacts eyes, flush with water for 15 minutes and get prompt medical attention. Review the safety instructions on page 2.

REFER TO THE PHOTOS AT RIGHT

1. Unplug the charger from the wall outlet, and unplug the AC pump and the blue

2. Remove the cover of the battery box by pushing in the tabs on the front and back, and then lifting up.
3. Fan the area around the top of the battery with a piece of cardboard (or another nonmetallic material) to remove any hydrogen or oxygen gas that may have been emitted from the battery.
4. Unscrew the bolts. Remove the battery cables.
5. Clean the battery bolts with a battery terminal cleaner or a wire brush.
6. Clean any corrosion off of the ring connectors on the ends of the battery wires. Use a stiff brush or sandpaper. **DO NOT** apply corrosion-resisting sprays or pads to the terminal rings or posts after you have cleaned them, since this could prevent the system from charging properly.
7. Replace the battery cables, RED to the POSITIVE (+) bolt and BLACK to the NEGATIVE (-) bolt. Tighten the bolts into the proper terminal. Replace the cover on the battery box.

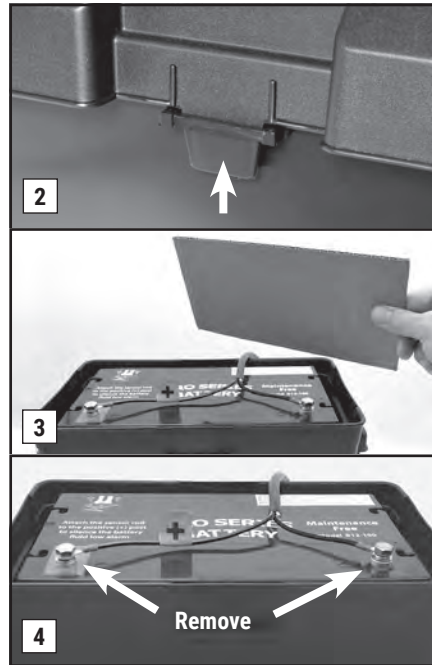

8. (a) Plug the charger back into the wall outlet. (Provide additional protection for the backup controller by using a surge protector.) (b) Then plug the piggyback controller into the wall outlet and the AC pump into the piggyback controller.
9. If any of the alarms are sounding, press the RESET button on the front panel of the control unit for one (1) second.

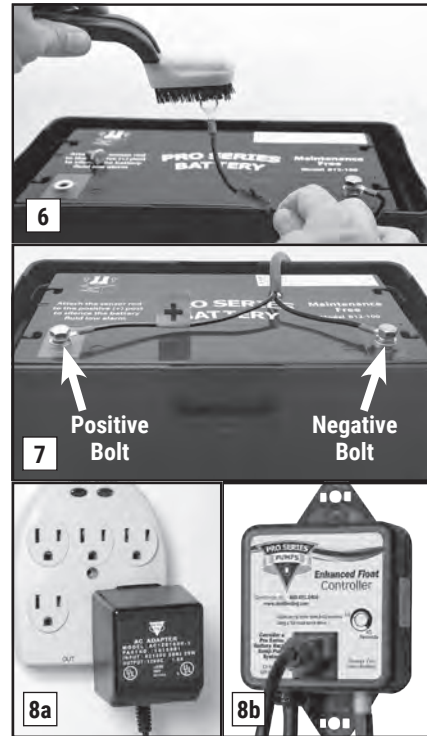

REPLACING THE BATTERY

⚠ DANGER

Risk of electrical shock or battery explosion, which can cause serious injury or death. Wear eye protection. Work in a well-ventilated area. Do not smoke or allow a spark or flame in the vicinity of the battery. Avoid dropping metal tools on the battery. If battery acid contacts eyes, flush with water for 15 minutes and get prompt medical attention. Review the safety instructions on page 2.

REFER TO THE PHOTOS AT RIGHT

1. Unplug the charger from the wall outlet,

- and unplug the AC pump and the blue piggyback controller.
2. Remove the cover of the battery box by pushing in the tabs on the front and back, and then lifting up.
3. Fan the area around the top of the battery with a piece of cardboard (or another nonmetallic material) to remove any hydrogen or oxygen gas that may have been emitted from the battery.
4. Unscrew the bolts and remove the battery cables.
5. Remove the old battery from the battery box and place the new battery in the box.
6. Clean any corrosion off of the ring connectors on the ends of the battery wires. Use a stiff brush or sandpaper. **DO NOT** apply corrosion-resisting sprays or

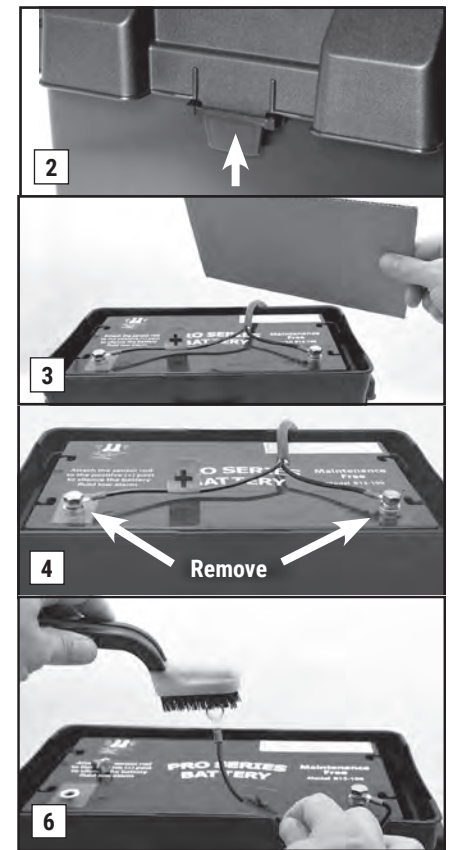

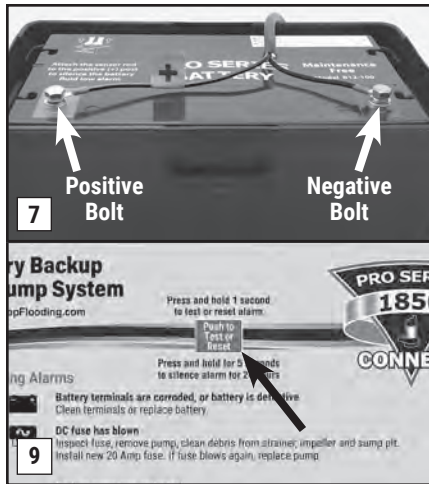

Remove the battery cover and clean the terminal rings or bolts after you have cleaned them, since this could prevent the battery from charging properly.

- Replace the battery cables, RED to the POSITIVE (+) bolt and BLACK to the NEGATIVE (-) bolt. Tighten the bolts into the proper terminal. Replace the cover on the battery box.
- Plug the charger back into the wall outlet. (Provide additional protection for the backup controller by using a surge protector.) Then plug the piggyback controller into the wall outlet and the AC pump into the piggyback controller.
- If any of the alarms are sounding, press the RESET button on the front of the control panel for one (1) second.



Unplug the main AC pump and piggyback controller before servicing the backup pump to avoid electric shock. Failure to do so could cause serious injury or death.

This alarm indicates that the 20-Amp safety fuse on the back of the control unit has blown. This can be the result of a clogged pump motor, or pump wires that have been shorted out. To determine the problem:

REFER TO THE PHOTOS AT RIGHT

- Check the pump plug in the back of the control unit to make sure it is firmly connected. Check the pump wires to make sure they are connected securely to the pump plug. Check the rest of the pump wires for any possible breaks.
- If the pump wires are intact, the pump may be clogged. (a) Disconnect the control unit from the wall outlet, and disconnect the battery cables. (b) Release the union and remove the pumps from the sump pit. (c) Clear any debris from the strainer. Debris may be clogging the impeller. To clear, follow steps for 'replacing the backup pump'. When the backup pump is off the sump foot, remove the strainer and clear any debris. Then reconnect the pump to the discharge pipe. (d) Connect the control unit, and the battery cables to the battery—

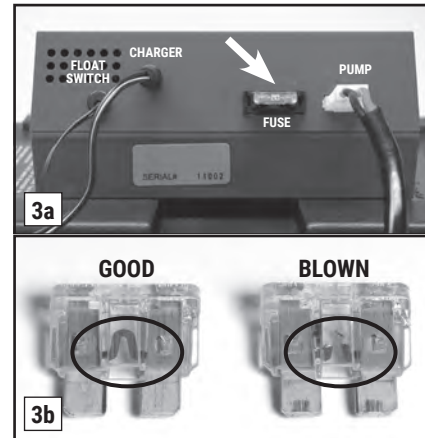
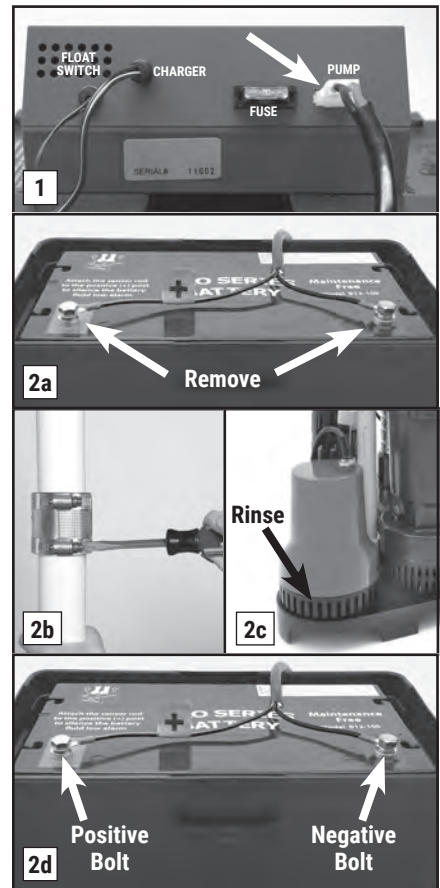

connect the RED wire to the POSITIVE (+) bolt, and then the BLACK wire to the NEGATIVE (-) bolt. Tighten the bolts into the proper terminal. (e) Plug the control unit back into the wall outlet.

- (a) Check the DC fuse by pulling it out of the fuse holder. (b) If the wires are burned and broken, replace the fuse with a 20-Amp DC safety fuse. If the fuse blows again, unplug the computer control unit from the wall and disconnect the battery cables from the battery. Then call Glentronics technical support for instructions at 800-991-0466. You may need to replace the pump.
- Plug the main AC pump and piggyback controller back into the wall outlet.



When the water rises in the sump pit and activates the float switch, the pump will begin pumping, and the "Backup pump was activated" light and alarm will turn on. Try to determine what caused the system to activate.

- Check the main AC pump for proper operation. It may not be working, the float switch may be stuck, or it may be too small to handle the inflow of water.
- Make sure the check valves are working.
- Make sure the discharge pipe is not clogged or frozen.
- If the power was out, the backup pump was automatically activated. You need to push

the RESET button on the front of the control panel to silence the alarm. The pump will continue to operate even if the reset button is not pressed.

REPLACING THE BACKUP PUMP

Before you begin this process, you will need a new AC pump, new check valves, and new wire ties. The check valves have a 1½" MPT on one end, and a ½" SLIP on the other end. The check valves also have a predrilled 3/16" air bleed hole. The 3/16" air bleed hole is required to help prevent an air lock within the system. See page 13 for part numbers.



Risk of electrical shock or battery explosion, which can cause serious injury or death. Wear eye protection. Work in a well-ventilated area. Do not smoke or allow a spark or flame in the vicinity of the battery. Avoid dropping metal tools on the battery. Review the safety instructions on page 2.

YOU WILL BE DISCONNECTING ALL THE WIRES. BE SURE THEY DO NOT FALL INTO THE SUMP PIT.

REFER TO THE PHOTOS ON PAGE 9

- Unplug the primary pump, and its blue piggyback controller from the wall outlet. Unplug the charger for the backup pump control unit, too.
- Unplug the backup pump from the back of the backup control unit.
- Remove the cover of the battery box and fan the area around the top of the battery with a piece of cardboard (or another nonmetallic material) to remove any hydrogen or oxygen gas that may have been emitted from the battery.
- Remove the battery wires from the battery terminals. Be sure they do not touch each

other while one is connected to the battery.

5. Slowly loosen the no-hub coupling on the top of the combination pump assembly to separate the pipes. The water trapped in the pipe will pour out into the sump as the no-hub coupling is loosened.
6. Separate the pump assembly from the no-hub coupling and lift it out of the sump pit by the handle on the primary pump. Tip the assembly over the sump pit to drain away any remaining water.
7. Lay the pumps down and remove the two (2) screws holding the backup pump to the sump foot.
8. Loosen the hose clamps on the no-hub connectors on both pumps.
9. Ease the wye assembly off of both pumps.
10. While you have the pump apart, this would be a good time to replace the check

valves. Contact Glentronics, Inc. to order check valves with a 1½-inch MPT on one end, a ½-inch SLIP on the other end and a predrilled ⅜-inch air bleed hole (#1141007). The air bleed hole helps prevent an air lock within the system.

11. Remove the old check valve from the old pump and screw it onto the new pump if you are not installing a new check valve. Be sure to check the valve for proper operation.
12. Now, reverse the process. Replace the pump by first screwing the adapter assembly into the new pump.
13. Screw the pump to the pump stand.
14. Ease the wye assembly back onto the check valves, and tighten the hose clamps.
15. Lower the pumps into the sump pit by the handle on the primary pump.
16. Connect the top of the system to the no-hub coupling and tighten the hose clamp.
17. Connect the backup pump to the back of the backup control unit.

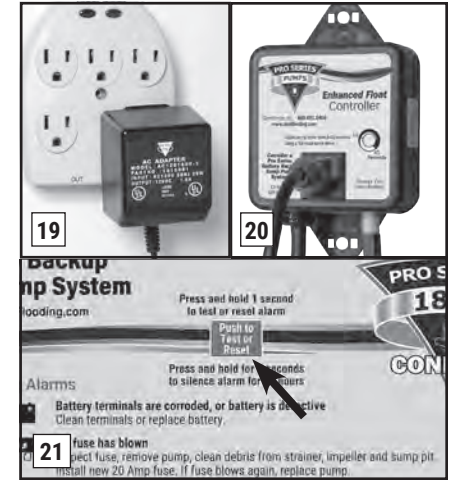
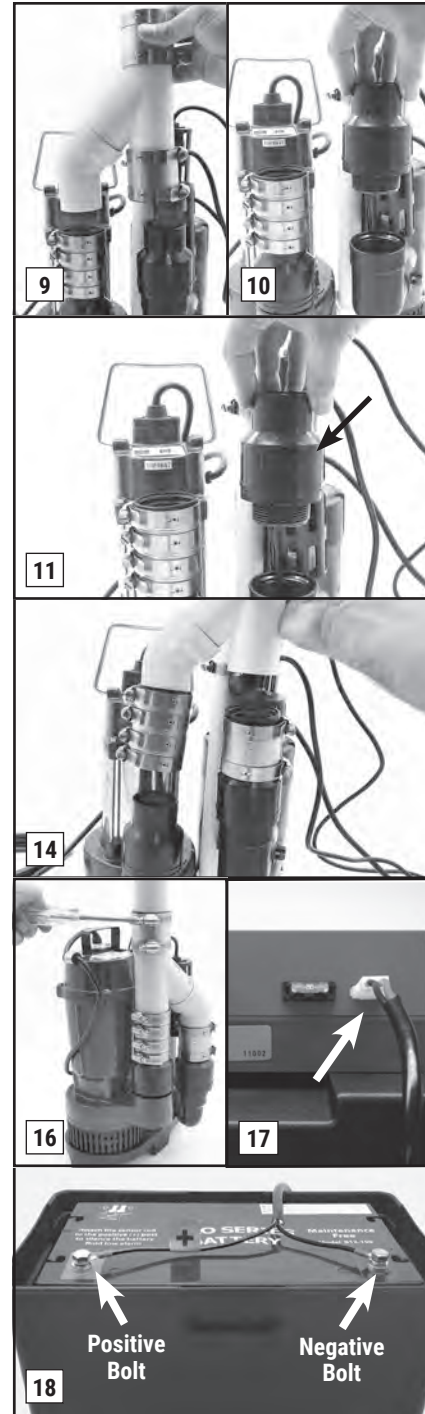
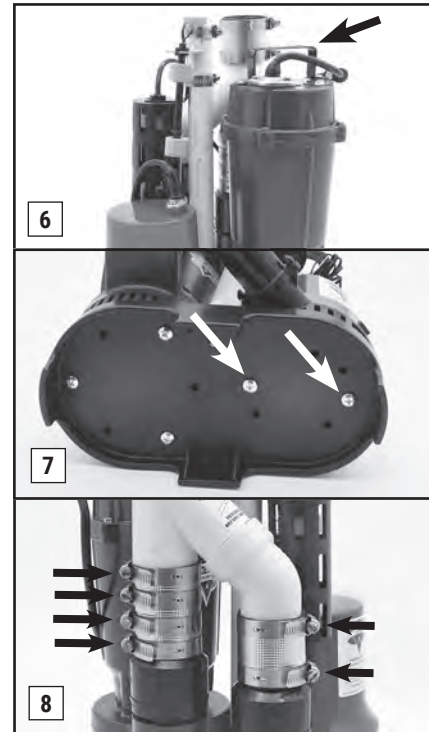
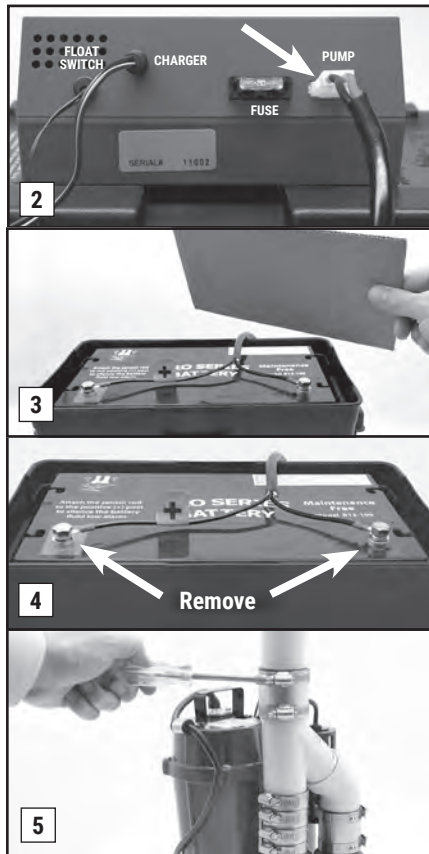

18. Connect the battery wires to the battery bolts, RED to the POSITIVE (+) post and BLACK to the NEGATIVE (-) post. Replace the cover on the battery box.
19. Plug the power cord from the backup control unit into the outlet. Provide additional protection for the system by using a surge protector.
20. Plug the primary pump into the receptacle on the blue Enhanced controller and then plug the power cord from the controller into the wall outlet.
21. If any of the alarms are sounding, press the RESET button for 1 second.
22. After the backup pump is replaced, be sure to check the pump operation by filling the sump pit with water and observing the pump through several full cycles.

REPLACING THE PRIMARY PUMP

Before you begin this process, you will need a new AC pump, new check valves, and new wire ties. The check valves have a 1½-inch MPT on one end, and a ½-inch SLIP on the other end. The check valves also have a predrilled ⅜-inch air bleed hole. The air bleed hole is required to help prevent an air lock within the system. See page 13 for part numbers.



⚠ DANGER

Risk of electrical shock or battery explosion, which can cause serious injury or death. Wear eye protection. Work in a well-ventilated area. DO NOT smoke or allow a spark or flame in the vicinity of the battery. Avoid dropping metal tools on the battery. Review the safety instructions on page 2.

YOU WILL BE DISCONNECTING ALL THE WIRES. BE SURE THEY DO NOT FALL INTO THE SUMP PIT.

1. Unplug the primary pump, the blue controller, and the power cord for the backup control unit from the wall outlet.
2. Unplug the backup pump from the back of the backup control unit.
3. Remove the cover of the battery box and fan the area around the top of a vented battery with a piece of cardboard (or another nonmetallic material) to remove any hydrogen or oxygen gas that may have been emitted from the battery.
4. Remove the battery wires from the battery posts. Be sure they **DO NOT** touch each other while one is connected to the battery.
5. Slowly loosen the no-hub coupling on the top of the combination pump assembly to separate the pipes. The water trapped in the pipe will pour out into the sump as the no-hub coupling is loosened.
6. Lift the pump assembly out of the pit by

the handle on the primary pump. Tip the assembly over the sump pit to drain any remaining water.

7. Lay the pumps down and remove the three (3) screws holding the primary pump to the sump foot. The strainer on the primary pump will separate from the pump when the screws are removed. **SAVE THESE SCREWS** or replace them with #10-24 x 1½-inch stainless-steel screws.
8. Loosen the hose clamps on the no-hub connector on top of the primary pump and ease the pump out of the connector. You may need to loosen the hose clamps on the backup pump.
9. While the pump is apart, it is a good time to replace the check valves. Contact Glentronics, Inc. to order check valves with a 1½-inch MPT on one end, a 1½-inch SLIP on the other end and a predrilled 3/16-inch air bleed hole (#1141007). The air bleed hole is required to help prevent an air lock within the system.

10. Remove the screws from the strainer on the new primary pump and discard them before you place it on the sump foot. You will need to thread the old screws through the foot, the strainer and into the pump.
11. Line up the discharge pipes parallel to each other and start with the top screw. Once the top screw is replaced, the other screws will line up with the holes. Tighten all the screws.
12. Ease the pumps back into the no-hub connectors and tighten the hose clamps.
13. Lower the pump back into the pit by the handle of the primary pump.
14. Connect the top of the system to the no-hub coupling and tighten the hose clamp.

15. Connect the backup pump to the back of the backup control unit.
16. Connect the battery wires to the battery posts, RED to the POSITIVE (+) bolt and BLACK to the NEGATIVE (-) bolt. Replace the cover on the battery box.
17. Plug the power cord from the backup control unit into the outlet. Provide additional protection to the system by using a surge protector.
18. Plug the primary pump into the receptacle on the blue Enhanced controller and then plug the power cord from the controller into the wall outlet.

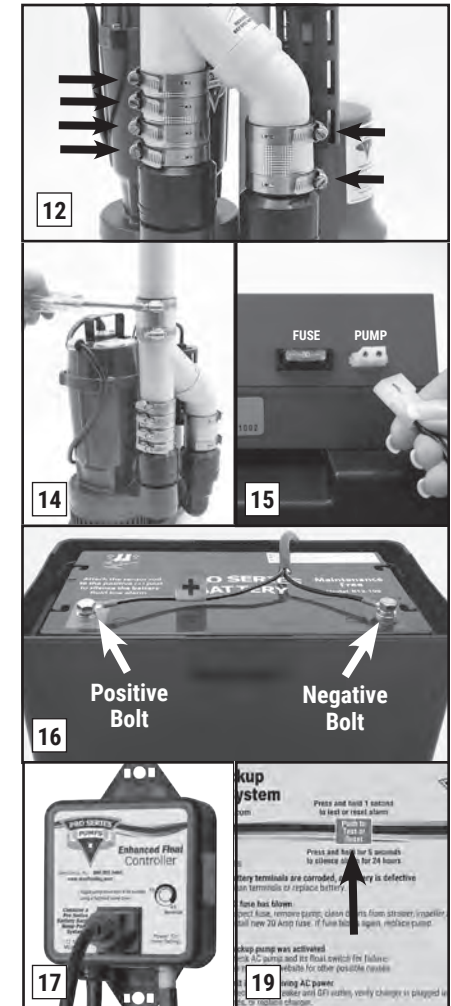
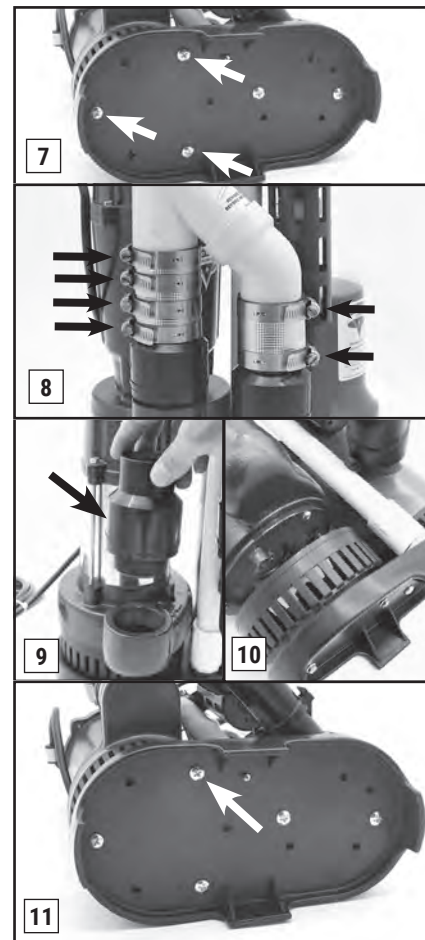
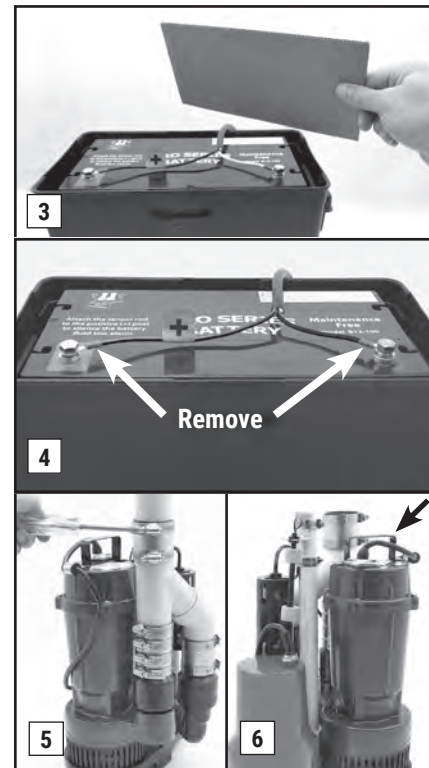
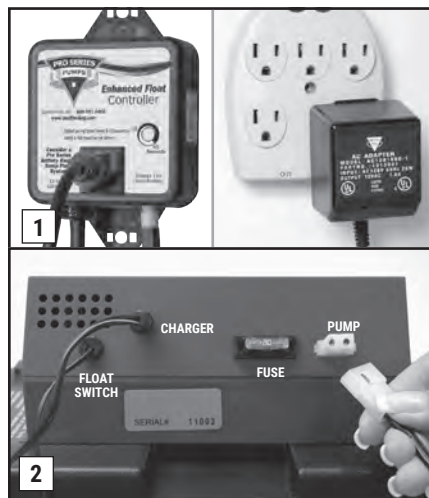

- If any of the alarms are sounding, press the RESET button for 1 second.
- After the primary pump is replaced, be sure to check the pump operation by filling the sump pit with water and observing the pump through several full cycles.

4  **Unit is not receiving AC power**

Power failure could have several causes, the most common being a power outage by your electric company. During this emergency, the Pro Series system will automatically switch to battery power and protect your basement from flooding.

You can silence the "AC power failure" alarm for 24 hours by pressing the RESET button on the front of the control panel for five (5) seconds. The alarm will be silenced, but the light will stay on. The system will continue to operate while the power alarm is silenced. After 24 hours, the alarm will reset automatically.

- If the power is on in the rest of the house, check the home circuit breaker or fuse box for failure, and correct the problem. Check the outlet to make sure it is working.



- Check the charger. Make sure it is securely plugged into the wall outlet.
- Check the charger plug that fits into the rear panel of the control unit. Make sure it is securely plugged into the control unit.

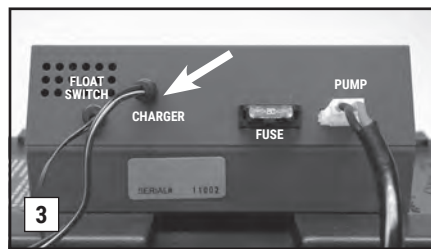



The control unit must receive 115 volts AC +/- 5% from the AC outlet. Any voltage lower than 110 volts will activate the power failure alarm. Lower voltages can be caused by utility company brownouts or a heavy power draw from other appliances on the same circuit. Reduce the number of appliances on the circuit.

If all the connections are secure and the wall outlet is operating, but the "AC power failure" warning light is still on, replace the charger unit with the Pro Series part number 1015010 from Glentronics at 800-991-0466.

5  **Charging**

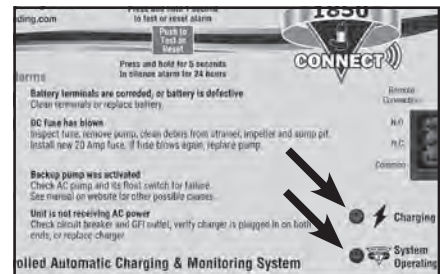
The Pro Series 1850 backup pump is equipped with a computer-controlled automatic charging system. The computer is constantly monitoring the battery and will supply a preprogrammed amount of energy to keep your battery at full charge. The "Charging" light will be ON when it is charging, FLASHING when it is maintenance (float) charging, and off when it is not charging. If the battery is discharged from extended use, the charger light will remain on until the battery is completely recharged.



6  **System operating**

This light will always be on when power is coming from either the battery or the outlet.

TEST-RESET-SILENCE BUTTON

To test the pump, press the RESET button on the front of the control panel for one (1) second. The pump will run for 2 seconds and then shut off automatically.

To silence an alarm, press the RESET button for one (1) second. Some alarms cannot be silenced since action needs to be taken to prevent a flood.

To silence the alarms for 24 hours, press the RESET button for five (5) seconds until you hear a buzz. The alarms will automatically reactivate in 24 hours.

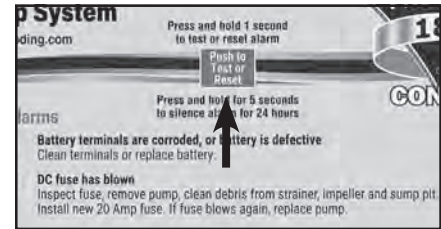

TESTING THE FLOAT SWITCH FOR THE BACKUP PUMP

It is important to manually test the float switches periodically or after any maintenance.

⚠ DANGER

Unplug the main AC pump when installing or servicing the backup pump to avoid electric shock. Failure to do so could cause serious injury or death. Review the safety instructions on page 2.

Lift the float up and let go. This will activate the pump. The control unit will run the pump for approximately 25 seconds so it can empty all the water in the sump pit. If no water is in the pit, the pump

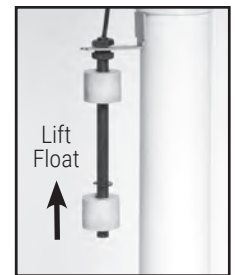

can run dry for this amount of time. The alarm will sound and the "Pump was activated" light will go on. After the pump has stopped, push the RESET button to silence the alarm. If the RESET button is pressed before the pump has stopped, the alarm will go off temporarily. Wait for the pump to stop pumping, and then push the RESET button on the front of the control unit to completely silence the alarm.

While the pumps are active, water will come out of the 3/16-inch hole that is drilled in the pipe above the pump, which is normal. The hole helps prevent an air lock within the system. **DO NOT** obstruct this hole or an air lock may stop the pump from activating.

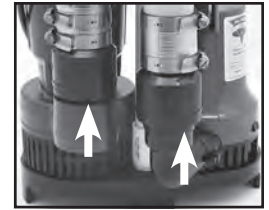

BE SURE TO PLUG IN THE MAIN AC PUMP WHEN YOU HAVE COMPLETED THE TEST.

TESTING THE FLOAT SWITCH FOR THE PRIMARY PUMP

It is important to manually test the float switches after initial installation or after any maintenance.

Lift the float up with a pencil, or another nonmetallic item, and let it go to activate the pump. The pump will run for an additional 10 seconds after the float returns to the original position. It will not damage the pump to run it for this short time if the sump pit is dry. However, **DO NOT** hold the float up for an extended time without water in the sump pit.

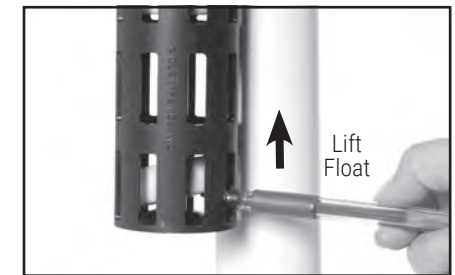

While the pumps are active, water will come out of the 3/16-inch hole that is drilled in the pipe above the pump. This is normal. The hole is needed to prevent an air lock within the system. **DO NOT** obstruct this hole or an air lock may prevent the pump from activating.

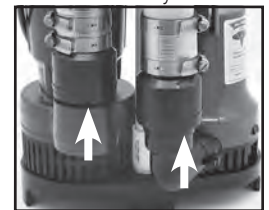

Using the Remote Notification

THE REMOTE TERMINAL

The Pro Series 1850 can be connected to a home security system or other alarm devices to alert you to a problem or required maintenance.

INSTRUCTIONS FOR CONNECTING THE REMOTE ALARM

The terminal is located on the front of the control unit. The terminal has three (3) positions for wire connections: N.C. (normally closed), N.O. (normally open), and common.

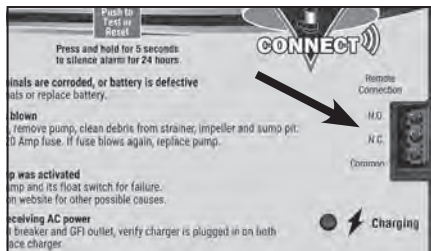

Check your security system to determine whether an open (no contact) or closed (making contact) connection is needed to activate the alarm.

The security system will provide two connection terminals. Extend wires from the security system to the Pro Series control unit. Strip the two wires, ¼-inch each. Connect either wire to the common terminal. To secure the wire into the terminal, insert the exposed wire into the hole on the back of the terminal next to the screw marked common. Turn the screw a few turns to lock in the wire.

If the security system requires a closing of a contact to activate the alarm, secure the other wire in the terminal hole labeled N.O. (normally open). If the security system requires an opening of a contact, secure the wire in the terminal hole labeled N.C. (normally closed).

USB DATA PORT

This system has a USB port on the side of the controller. The purpose of this port is to allow communication with the Pro Series CONNECT Module. **DO NOT** connect any other device to the USB data port other than a Pro Series WiFi CONNECT Module.

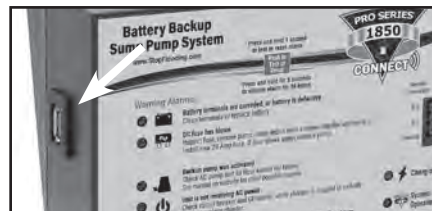

CONNECT MODULE



The Pro Series CONNECT Module is a separately sold accessory that will allow the user to stay connected and receive remote notifications of potential problems and needed maintenance while away from home.



Pro Series WiFi Module (Model PS-WiFi2)

- Sends emails, texts or push notifications and status alerts to your phone, tablet or computer
- No required monthly or yearly fees or subscriptions

For more information, please visit www.StopFlooding.com.

MAINTENANCE CHECKLIST

Maintenance should be performed 1-2 times per year

1. Lift the float switches on both pumps as described on page 11.
2. Remove all debris from the bottom of the pit and pump strainer.
3. Remove all debris floating in the water.
4. Remove all debris from the float switch cage.
5. Fill the pit with water. Make sure the pumps turn on at the intended levels.
6. While the pumps are running, make sure they are evacuating water at a good pace and water is coming out of the 3/16-inch air bleed holes. Make sure the air bleed holes are clear of debris.
7. Check and clean battery terminals.

PARTS & SERVICE INFORMATION

You can receive technical support, parts, or service information by calling Glentronics, Inc. at **800-991-0466**, or by visiting the Pro Series website at www.stopflooding.com. Send your unit to the following address if repairs are needed:

Glentronics, Inc., Attn: Repairs
645 Heathrow Drive
Lincolnshire, IL 60069-4205

Replacement Parts List

PS-C22 Description

| PS-C22 Description | Part No. |
|--|-------------------|
| Controller for backup pump | PHCC1850-CONT-AGM |
| Float switch for backup pump | FLOAT-DL-MC |
| Enhanced Dual Float switch with controller for AC pump | DFC1.5 |
| Float switch for AC pump controller | FLOAT-DLCH |
| 1/3 HP AC sump pump | S1033-NS |
| 1850 backup pump | 1011015 |
| Battery box | 1113003 |
| PVC wye pipe | 1120017 |
| Battery cap with hole | 1125000 |
| Sump foot | 1143000 |
| Stainless-steel screw, #14 x 3/4" * | 1100024 |
| Stainless-steel screw, #8-18 x 3/8" * | 1100010 |
| Pipe adapter for backup pump, 1 1/2" FTP x 1 1/2" slip * | 1120009 |
| Wire tie for float switch, 11" * | 1122000 |
| Stainless-steel hose clamp, 2 1/2" diameter * | 1122002 |
| Check valve, 1 1/2" MPT x 1 1/2" SLIP * | 1141007 |
| No-hub coupling, 1 1/2" * | 1142000 |
| No-hub coupling, (long) | 1142004 |
| Backup charger | 1015010 |

* Stock items available in plumbing department

Call 800-991-0466 to order parts.

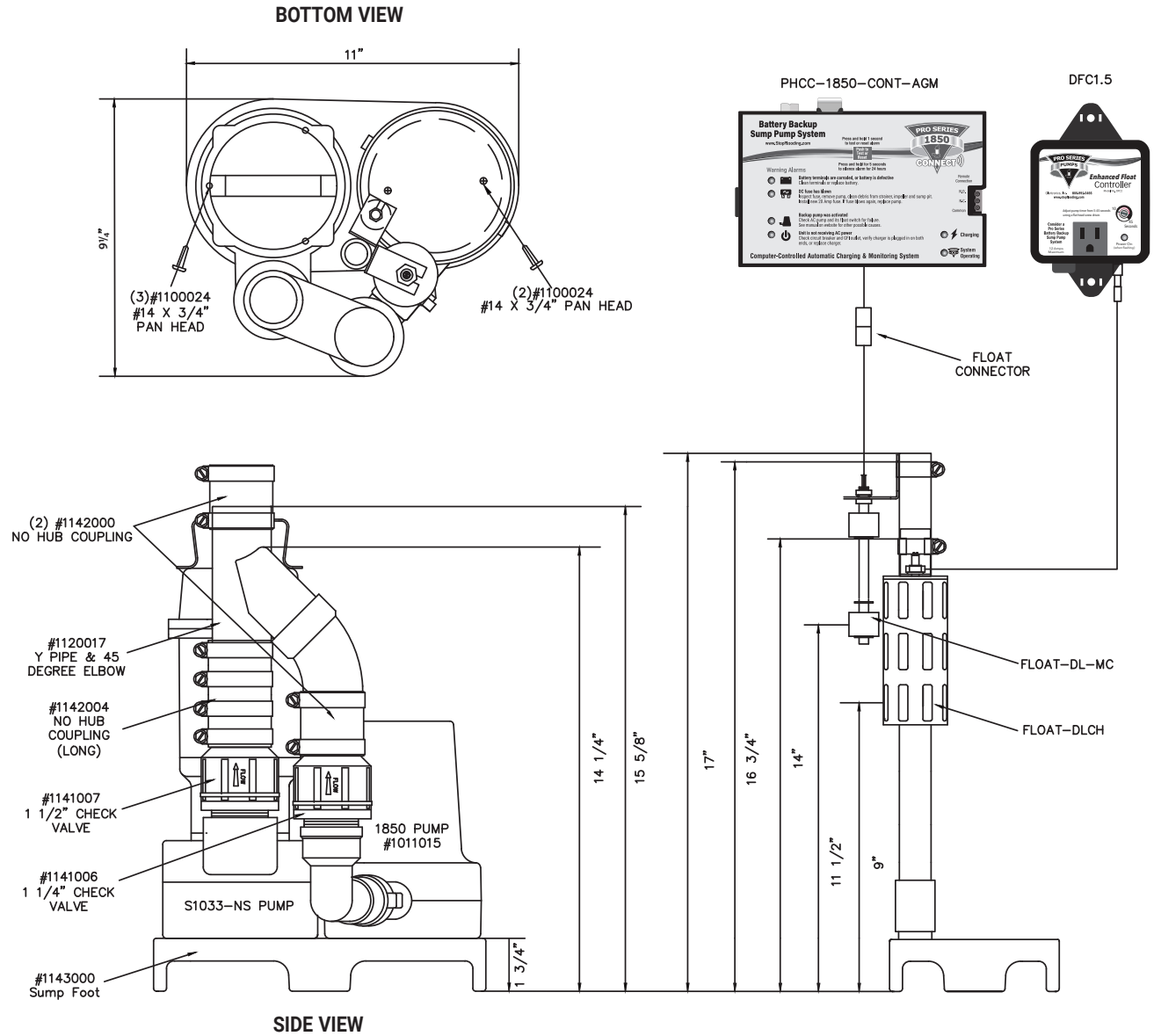

Primary Pump Troubleshooting Guide

⚠ DANGER Read safety warnings & instructions before attempting any repairs or maintenance.

| Potential Cause | THE PUMP WILL NOT START OR RUN | Solutions |
|--|---|-----------|
| Pump is not plugged in..... | Plug pump in properly (see instructions) | |
| No AC power..... | Check circuit breaker or fuse, and GFI reset button | |
| Poor power source..... | Check circuit line wires, cable and outlet | |
| Locked impeller..... | Remove strainer and clear obstruction | |
| Defective float switch..... | Replace float switch with new float switch | |
| The float switch is not connected to the controller..... | Check connection of the float switch to the controller | |
| Defective pump..... | Replace pump with new pump | |
| Potential Cause | THERMAL PROTECTOR TRIPPING OR NOT FUNCTIONING | Solutions |
| Locked impeller..... | Remove strainer and clear obstruction | |
| Incorrect power supply..... | Check power supply source and voltage | |
| Pump running continuously with no water present..... | Check float switch | |
| Potential Cause | PUMP STARTS AND STOPS TOO FREQUENTLY | Solutions |
| Float switches mounted too low..... | Raise both float switches | |
| Water backflowing from pipe..... | Install or replace check valve | |
| Malfunctioning float switch..... | Replace float switch with new float switch | |
| Potential Cause | PUMP WILL NOT SHUT OFF | Solutions |
| Clogged or frozen discharge..... | Clear blockage or thaw frozen line | |
| Blocked intake strainer..... | Clear debris from intake strainer | |
| One or both of the floats is obstructed and cannot drop down..... | Clear debris from inside the float cage (Loosen nut on top of float, then remove c-clip on bottom of float. Remove debris. Tighten nut on top of float, then replace c-clip on bottom of float.) When reassembling the float, the magnetic strip on the inside of the float should be facing down | |
| Defective float switch..... | Replace float switch with new float switch | |
| Check valve is stuck..... | Replace check valve | |
| Potential Cause | INSUFFICIENT OR NO WATER VOLUME | Solutions |
| Check valve on secondary pump will not close and water recirculates within the system..... | Replace the check valve on the secondary pump | |
| Partially blocked impeller..... | Remove strainer and clear obstruction | |
| Clogged or frozen discharge pipe..... | Clear blockage or thaw frozen line | |
| Broken or leaking pipe..... | Repair pipe | |
| Low power voltage..... | Check power voltage, wires and cable condition | |
| Check valve is stuck..... | Replace check valve | |
| The system has an air lock..... | Make sure the 3/16-inch air bleed hole located on the check valve is clear of debris | |
| Potential Cause | ABNORMAL SOUND OR VIBRATION | Solutions |
| Check valve is broken..... | Replace the check valve | |
| Blocked intake screen..... | Clear debris from intake screen | |
| Defective pump..... | Replace pump | |

If the listed solutions do not resolve the problem, follow the instructions within this manual to disconnect the system from the outlet and battery terminals, and then reconnect the system and push the RESET button. If the problem continues, contact customer service at 800-991-0466.

Backup Pump Troubleshooting Guide

⚠ DANGER Read safety warnings & instructions before attempting any repairs or maintenance.

| Potential Cause | BATTERY PROBLEM | Solutions |
|--|--|-----------|
| Terminals are corroded..... | Clean terminals and cables | |
| Cables are loose..... | Tighten wing nuts or bolts | |
| Battery is discharged below 25%..... | Replace battery if power is out. Only ½ hour of continuous pumping power is left. Battery will recharge when power is restored | |
| Battery is old or damaged..... | Replace battery | |
| Potential Cause | POWER FAILURE | Solutions |
| Power outage..... | None. The backup pump will run off of the battery. Press and hold the RESET button for 5 seconds to silence the alarm for 24 hours | |
| An outlet, fuse, or circuit breaker has failed..... | Try another outlet, replace the fuse, or reset the circuit breaker | |
| The charger is unplugged from the wall or the back of the controller..... | Make sure the power cord is plugged in securely | |
| The charger is receiving less than 110 volts from the outlet..... | None, if the utility company has instigated brownouts. Otherwise, reduce the number of other appliances on the circuit | |
| The charger has taken a power surge and has been damaged or failed..... | Test charger (output should be 14 V/AC +/-) or call Glentronics to order replacement | |
| Potential Cause | PUMP WILL NOT TURN ON | Solutions |
| Backup pump is unplugged..... | Make sure the pump is securely plugged into the back of the control unit | |
| Backup pump is clogged..... | Remove strainer from pump and clean out any debris | |
| The float switch is not connected to the controller..... | Check connection of the float switch to the controller | |
| Backup pump is broken..... | Replace the pump | |
| Potential Cause | PUMP WAS ACTIVATED | Solutions |
| The main AC pump failed because of a power outage..... | None. The backup pump was activated when needed | |
| The float switch on the main AC pump is stuck or defective..... | Free the float switch on the main pump or replace it | |
| The main AC pump is broken..... | Replace the main AC pump | |
| The main AC pump could not keep up with the inflow of water..... | None. The backup pump was activated as needed. If this is a recurring problem, install a higher-capacity main pump | |
| The check valve is stuck and the water cannot pass through it..... | Replace the check valve | |
| The discharge pipe is clogged or frozen and the water cannot pass through it..... | Thaw, clean out the blockage, or replace the discharge pipe | |
| A slight chance of false activation exists if the float switch cord is wrapped around the AC power cord..... | Move the float switch cord away from the AC power cord | |
| The system has an air lock..... | Make sure the 3/16-inch air bleed hole located on the check valve is clear of debris | |
| Potential Cause | ABNORMAL SOUND OR VIBRATION | Solutions |
| Check valve is broken..... | Make sure check valve is functioning, or replace it | |
| Discharge pipe is clogged or frozen..... | Clear the discharge pipe | |

Limited Warranty

By opening this package and using this GLETRONICS, INC. product, you are agreeing to be bound by the terms of the GLETRONICS, INC. limited warranty ("warranty") as set out below. Do not use your product until you have read the terms of the warranty. If you do not agree to the terms of the warranty, do not use the product and return it within the return period stated on your purchase receipt from the retail store or authorized distributor where you purchased it for a refund.

To the extent permitted by law, this warranty and the remedies set forth are exclusive and in lieu of all other warranties, remedies and conditions, whether oral, written, statutory, express or implied. GLETRONICS, INC. disclaims all statutory and implied warranties, including without limitation, warranties of merchantability and fitness for a particular purpose and warranties against hidden or latent defects, to the extent permitted by law. GLETRONICS, INC. will not be liable for any incidental, special or consequential damages for breach of any express or implied warranties on this product. In so far as such warranties cannot be disclaimed, GLETRONICS, INC. limits the duration and remedies of such warranties to the duration of this express warranty and, AT GLETRONICS, INC.'s option, the repair or replacement services described below. Some states (countries and provinces) do not allow limitations on how long an implied warranty (or condition) may last, so the limitation described above may not apply to you.

Any and all causes of action arising from, filed as a result of or in reference to, this warranty or the products described under this warranty shall be governed by and construed under the laws of the State of Illinois. Any cause of action arising from, filed as a result of or in reference to, this warranty or the products described under this warranty shall be filed only in the Circuit Court of the 18th Judicial District, Lake County, Waukegan, Illinois, or in the Northern District of Illinois if filed in Federal Court. The maximum liability for any product described in this warranty shall be the cost of product replacement only.

If any term is held to be illegal or unenforceable, the legality or enforceability of the remaining terms shall not be affected or impaired.

What is Covered by this Warranty?

GLETRONICS, INC. warrants to the end purchaser that its pumps, switch and control unit products are free from defective materials and workmanship for the periods indicated below:

All parts and labor (excluding installation) for a period of:

- 3 years from the date of installation, when used intermittently as a sump pump

The defective product must be returned directly to the factory, postage prepaid with the original bill of sale or receipt to the address listed below. GLETRONICS, INC., at its option, will either repair or replace the product and return it postage prepaid.

What is NOT Covered by this Warranty?

This warranty does not cover the cost or value of damaged property, including expressly any property that has been affected by water overflow, seepage or flooding. If GLETRONICS, INC. determines that a product is deemed defective under this warranty agreement, it will repair or replace the PRODUCT ONLY. GLETRONICS, INC. will not cover the cost to reinstall the product, nor will GLETRONICS, INC. pay the cost of having a plumber or contractor repair or replace the product.

GLETRONICS, INC. will not repair or replace a product that was installed incorrectly. A product shall be considered "installed incorrectly" when it deviates in any way from the instructions described in this manual.

This warranty does not cover product problems resulting from handling liquids hotter than 104 degrees Fahrenheit, handling inflammable liquids, solvents, strong chemicals or severe abrasive solutions; user abuse; misuse, neglect, improper maintenance, commercial or industrial use; improper connection or installation, damages caused by lightning strikes; excessive surges in AC line voltage; water damage to the controller; other acts of nature, or failure to operate in accordance with the enclosed written instructions.

How to Obtain Warranty Service

Within thirty (30) days of the product's defective performance, the unit must be shipped, freight prepaid, or delivered to GLETRONICS, INC. to provide the services described hereunder in either its original carton and inserts, or a similar package affording an equal degree of protection. Products not received by GLETRONICS, INC. at the address indicated below within thirty (30) days of the product's defective performance will not be considered for warranty service. Products received after three (3) years from the date of purchase, fall outside of the timeframe for warranty service and will not be eligible for warranty service. The product must be returned to GLETRONICS, INC. for inspection in order to be considered for warranty service. If the product is not returned to GLETRONICS, INC. or the product is inspected by any person, plumber, contractor or business other than GLETRONICS, INC., this warranty shall no longer be valid. Prior to defective operation, the unit must not have been previously altered, repaired or serviced by anyone other than GLETRONICS, INC., or its agent; the serial number on the unit must not have been altered or removed; the unit must not have been subject to accident, misuse, abuse or operated contrary to the instructions contained in the accompanying manual. The dealer's dated bill of sale, or installer's invoice must be retained as evidence of the date of purchase and to establish warranty eligibility.

Where are Products Sent for Warranty Service?

Glentronics, Inc., 645 Heathrow Drive, Lincolnshire, IL 60069

How Can I Obtain More Information?

By calling 800-991-0466

Additional Products to Help Protect Your Basement

Maintenance Free Battery B12-100



Compatible with:

- All current Pro Series backup and combo systems

Pro Series Maintenance Free/AGM Standby Batteries are designed to:

- Provide dependable service without having to add battery fluid or distilled water
- Run the pump longer for more hours per charge
- Work with all backup and combination systems
- Last longer in standby operation



Clenit™ Pump and Pit Cleaner CL7

CL7



FEATURES AND BENEFITS:

- Removes iron ochre, the red slime buildup, from your sump system and pit
- Helps to keep your pump and pit healthy
- Great solution for periodic pit maintenance

Easy to Use:

- Pour Clenit™ into your sump system
- Allow the proprietary powder to attack the iron ochre
- Fill your pit with water so that your pump evacuates the pit and expels the iron ochre

Pro Series CONNECT™ WiFi2 Module

PS-WiFi2



FEATURES AND BENEFITS:

- Sends emails, texts or push notifications and status alerts to your phone, tablet or computer
- NO MONTHLY FEE
- Connect using home Wi-Fi
- Simple setup
- Pro Series CONNECT free mobile app allows you to see your backup pump status and receive updates

Sewage Pump E7055



FEATURES AND BENEFITS:

- ½ HP
- 5,340 GPH (89 GPM) at 10-foot lift
- Cast-iron construction
- Energy-efficient permanent split capacitor (PSC) motor
- Handles 2-inch solids through a 2-inch discharge
- Continuous-duty rated
- Dual carbon/ceramic seals plus (1) Buna-N-Seal
- Upper and lower sealed ball bearings
- Stainless-steel fasteners
- Cast-iron impeller
- 3-year warranty