



# PAIR OF PUMPS

# Instruction Manual & Safety Warnings

## Combination Primary and Backup Sump Pump System Model PS-C50

### Table of Contents

<b>Important Safety Warnings and Instructions</b>		
Electrical precautions	2	Cleaning battery terminals
Battery preparation	2	Not receiving AC power
Battery precautions	2	Fuse alarm
<b>Introduction</b>		Backup pump activated
Items included in system	3	Replacing the backup pump
Additional items needed	3	Replacing the primary pump
System specifications	3	Battery power level
<b>Installing the Pipe and Pump</b>	4	<b>Remote Notification</b>
<b>Battery Instructions</b>	5	Remote Terminal
<b>System Connections</b>		Remote Alarm
Connecting the backup pump	5	<b>USB Data Port</b>
Connecting the battery	5	<b>CONNECT Module</b>
Connecting the primary pump	5	<b>Testing the System</b>
<b>Product Operation</b>		Testing the backup float switch
Float switches	5	Testing the primary float switch
Controllers	6	<b>Maintenance Checklist</b>
3/16" weep holes	6	<b>Parts &amp; Service Information</b>
<b>Understanding the Warning Lights and Alarms</b>		Technical support
Silencing the alarm during an emergency	6	<b>Replacement Parts Diagram &amp; List</b>
Battery cables loose or battery defective	6,7	<b>Troubleshooting Guide</b>
Replacing the battery	6	<b>Warranty</b>
		<b>Other Products</b>



Scan the QR code for more information about the PS-C50 Combination Sump Pump System

**IMPORTANT:** Even if you have the Pro Series™ C50 Combination Sump Pump System installed by someone else, you must read and follow the safety information contained in this manual. Failure to do so could result in property damage, serious injury, or death.

## Important Safety Warnings & Instructions

**SAVE THESE INSTRUCTIONS.** This manual contains important SAFETY WARNINGS and OPERATING INSTRUCTIONS for the Pro Series combination sump pump system. You will need to refer to it before attempting any installation or maintenance. **ALWAYS** keep these instructions with the unit so that they will be easily accessible.

Failure to read and follow these warnings and instructions could result in property damage, serious injury, or death. It is important to read this manual, even if you did not install the Pro Series combination sump pump system, since this manual contains safety information regarding the use and maintenance of this product. **DO NOT DISCARD THIS MANUAL.**

## ELECTRICAL PRECAUTIONS

### ⚠ WARNING

This installation must be in accordance with the National Electric Code and all applicable local codes and ordinances.

### ⚠ DANGER

**Risk of electrical shock and fire hazard. May result in death, serious injury, shock or burns. To help reduce these risks, observe the following precautions:**

- **DO NOT** walk on wet areas of the basement until all power has been turned off. If the main power supply is in a wet basement, call an electrician.
- **ALWAYS** disconnect the pump from the power source before servicing or making adjustments.
- **ALWAYS** unplug the control unit and disconnect the cables from the battery before attempting any maintenance or cleaning.
- **NEVER** handle the pump or motor with wet hands or when standing on a wet or damp surface while the pump is plugged into the power source.
- **MAKE SURE A PROPERLY GROUNDED RECEPTACLE IS AVAILABLE.** This system is wired with 3-prong grounded plugs. To reduce the risk of electric shock, be certain that it is only connected to a properly grounded 3-prong receptacle. If you have a 2-prong

receptacle, have a licensed electrician replace it with a 3-prong receptacle according to local codes and ordinances.

- **NEVER** bypass grounding wires or remove the ground prong from the plug.
- **DO NOT** use an extension cord. The electrical outlet should be within the length of the pump's power cord, and at least 4' above the floor level to minimize potential hazards from flood conditions.
- **DO** protect the electrical cord from sharp objects, hot surfaces, oil and chemicals. Avoid kinking the cord.
- **MAKE SURE** the supply circuit has a dedicated fuse or circuit breaker rated to handle the power requirements noted on the nameplate of the pump.
- **DO NOT** use an attachment that is not recommended or sold by the manufacturer. It may result in a risk of fire or injury from an electrical shock.
- The maximum amperage for the primary controller is 12-Amps.

### CAUTION

To reduce the risk of hazards that can cause injury or property damage, observe the following precautions:

- **DO NOT** use the power cord or strain relief to carry the pumps. Use the handle of the main pump.
- **DO NOT** pull on the float switch cords.
- **DO NOT** pull on the cord to disconnect the system or the pump. Pull the plug.
- **DO NOT** expose the control units to water, rain or snow.
- **DO NOT** place the controllers on the floor. The electrical outlet should be within the length of the pump's power cord and at least 4' above the floor to minimize potential hazards from flood conditions.
- **DO NOT** operate the pumps or control units if they have been damaged in any way.
- **DO NOT** use pumps in pits handling raw sewage, salt water, or hazardous liquids. **This product is for groundwater use only.**
- **DO NOT** disassemble the pumps or control units. When service is required, contact Glentronics' technical support at 800-991-0466. Return the product to the manufacturer for any repairs at the following address:  
Glentronics, Inc., Attn: Service  
645 Heathrow Drive, Lincolnshire, IL 60069-4205

## BATTERY PREPARATION

### ⚠ WARNING/POISON

Sulfuric acid can cause blindness or severe burns. Avoid contact with skin, eyes, or clothing. In the event of an accident, flush with water and call a physician immediately. **KEEP OUT OF REACH OF CHILDREN.**

To help reduce these risks, observe the following precautions:

- Someone should be within range of your voice or close enough to come to your aid when you work near a lead-acid battery.
- Have plenty of fresh water and soap nearby in case battery acid contacts skin, clothing or eyes.
- Wear eye and clothing protection and avoid touching your eyes while working with battery acid or working near the battery.
- If battery acid contacts skin or clothing, wash immediately with soap and water. If acid enters eye, immediately flood eye with running cold water for at least 15 minutes and get prompt medical attention.

### ⚠ WARNING

Battery posts and terminals contain lead, lead compounds or chemicals known to the State of California to cause cancer, birth defects or other reproductive harm. Wash hands after handling. See [www.p65warnings.ca.gov](http://www.p65warnings.ca.gov) for more information.

### ⚠ WARNING

Battery fluid can expose you to chemicals including strong inorganic acid mists containing sulfuric acid, which is known to the State of California to cause cancer. For more information go to [www.P65warnings.ca.gov](http://www.P65warnings.ca.gov).

## BATTERY PRECAUTIONS

### ⚠ DANGER

Explosive gases could cause serious injury or death. Cigarettes, flames or sparks could cause battery to explode in enclosed spaces. Charge in well-ventilated area. Always shield eyes and face from battery. Keep vent caps tight and level.

Sulfuric acid can cause blindness or severe burns. Avoid contact with skin, eyes or clothing. In the event of accident, flush with water and call a physician immediately. **KEEP OUT OF REACH OF CHILDREN.**

To help reduce these risks, observe the following precautions:

- **NEVER** smoke or allow a spark or flame in

the vicinity of the battery.

- Use the Pro Series control unit for charging a LEAD-ACID battery only. **DO NOT** use the control unit for charging dry-cell batteries that are most commonly used with home appliances.
- Be sure the area around the battery is well-ventilated.
- When cleaning a vented battery, first fan the top of the battery with a piece of cardboard or another nonmetallic material to blow away any hydrogen or oxygen gas that may have been emitted from the battery.
- **DO NOT** drop a metal tool onto the battery. It might spark or short-circuit the battery and cause an explosion.
- Remove personal metal items such as rings, bracelets, watches, etc. when working with a lead-acid battery. A short circuit through one of these items can melt it, causing a severe burn.
- **ALWAYS** remove the charger from the electrical outlet before connecting or disconnecting the battery cables. **Never allow the rings to touch each other.**
- Check the polarity of the battery posts. The POSITIVE (+) battery post usually has a plus sign near it and the NEGATIVE (-) post has a minus sign nearby.

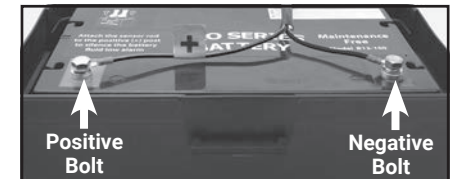

- When connecting the battery cables, first connect the large ring on the end of the RED wire to the POSITIVE (+) bolt and then connect the small ring on the end of the BLACK wire to the NEGATIVE (-) bolt of the battery.
- **Always** keep the cover secured on the battery box by slipping the tabs through the fittings on the front and back of the box. **DO NOT** place anything on top of the battery or the battery box cover.

### ⚠ DANGER

Do not use system to pump flammable or explosive fluids such as gasoline, fuel oil, kerosene, etc.

**DO NOT** use this system in pits handling raw sewage or other hazardous liquids.

## Introduction

The Pro Series pair of pumps combination system is designed to provide both primary and backup pumping capabilities. The primary pump will operate as long as it is receiving AC power. If the power is interrupted, or more water is coming into the sump than the AC pump can handle, the backup sump pump will begin pumping automatically. The backup system has unique monitoring features that diagnose a problem and sound an alarm. A light on the display panel of the control unit will indicate the cause of the alarm and the corrective action. The two systems have been preassembled for easy installation.

To extend the battery runtime, two batteries may be connected to the Pro Series C50 system by purchasing a second battery as well as a set of battery jumper cables. Jumper cables specifically designed for this use (Model PJC) are available from the manufacturer, Glentronics, Inc.

### The Combination Sump Pump System includes:

- A 1/3 HP primary pump with a caged dual float switch, and a blue piggyback controller that plugs into the wall outlet
- A gray backup pump
- A control unit with a dual float switch, battery cables, and an internal, 13-Amp charger
- A battery box
- A rubber union or no-hub coupling

### You will also need to supply:

- A Pro Series B12-100 standby battery. **Pro Series standby batteries are specifically designed to work with your battery backup sump pump system. Glentronics can not guarantee the compatibility of other brands of batteries. For optimal performance the use of a Pro Series standby battery is highly recommended.**

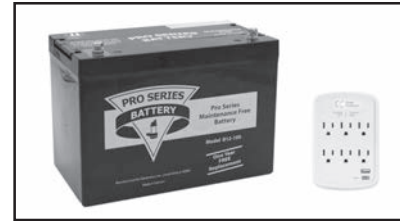

- **DO NOT** use an automotive battery with this system
- A surge protector (recommended for the backup controller)

### For some installations you may need these additional items:

- 1½" rigid PVC pipe to connect to the existing plumbing
- A PVC pipe connector or a rubber union
- PVC pipe cleaner and cement



### To connect two batteries you will need:

- Two (2) batteries of same type, age and capacity (so they will have equal power and charge properly). **DO NOT** use batteries of different types, ages or capacities.
- Another battery box
- A set of battery cables with rings on both ends to connect the two batteries together (Model PJC, available from Glentronics, Inc.)

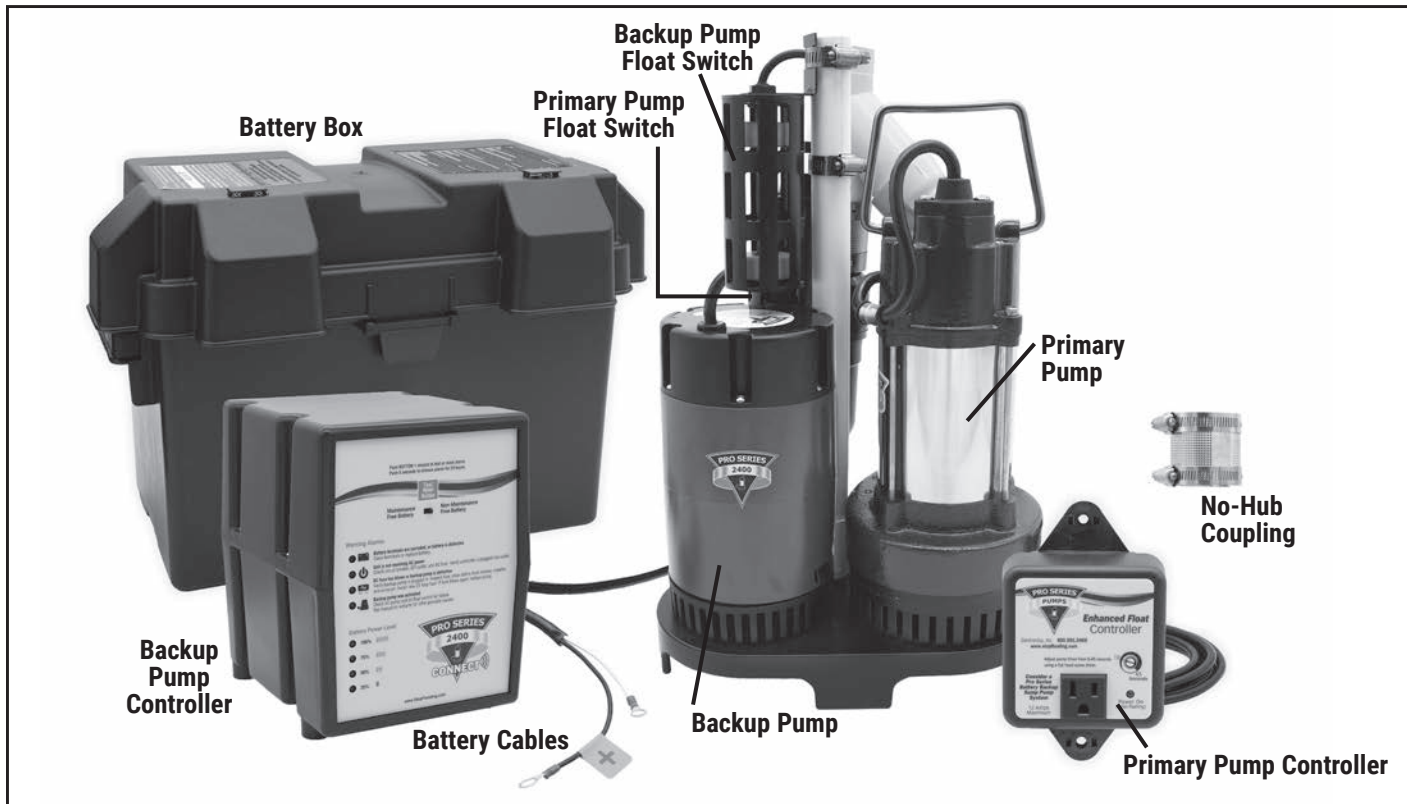

## System Specifications

Power supply requirements .. 115 volts, 60 Hz  
 AC pump pumping capacity.. 3,900 GPH @ 10'  
 .....65 GPM @ 10'  
 DC pump pumping capacity.. 2,400 GPH @ 10'  
 .....40 GPM @ 10'  
 Overall dimensions.... 11" W x 17½" H x 9¾" D



## Installing the Pipe and Pump

The Pro Series combination system is compact and will fit in a sump pit as small as 12" wide. It measures 17 $\frac{1}{8}$ " from the bottom of the pump stand to the top of the wye connector, where it will be attached to the discharge pipe.

Use a pit that conforms to all local codes, and check the code to see if a gate valve or ball valve is required.

The path of the existing vertical discharge pipe to an exterior wall should have the shortest path with the fewest turns. More turns will reduce the pumping capacity.

The discharge pipe must be positioned in a downward slope when it exits the building, allowing any remaining water to drain away. Failure to do so will allow the discharge line to freeze, preventing water from exiting.

The system should be placed on a flat surface free from dirt and debris. If the bottom of the sump pit is not clean, remove as much of the debris as possible. The pumps are attached to

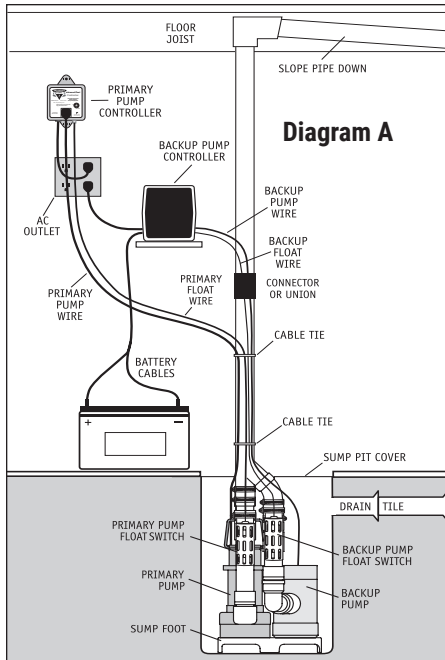

a sump foot (stand) to raise them above any debris. **(See Diagram A in column 1 below.)**

If you are replacing an old sump pump, unplug the pump from the outlet.

1. Remove the check valve or rubber union. **(Refer to photo 1 at right.)** Discard the check valve. The Pro Series system contains built-in check valves, so the old check valve will not be needed. If the existing system is installed without a check valve or rubber union, saw the pipe apart above the sump pit. **(Refer to the diagram in illustration 3 to the right.)**
2. Remove the old pump from the pit, and unscrew the pipe and pipe adapter from the pump. You can use this pipe to extend the discharge pipe, if needed.
3. Measure the distance from the bottom of the sump pit to the end of the discharge pipe. Subtract 18 $\frac{1}{8}$ " (the height of the pump system + 1"). Cut a piece of 1 $\frac{1}{2}$ " rigid PVC pipe to that length.
4. (a) Connect this piece to the discharge pipe by cementing the two pieces together with a 1 $\frac{1}{2}$ " PVC pipe connector. (Follow the instructions on the PVC pipe cleaner and cement.) OR, (b) connect the two pieces of pipe together with a no-hub coupling.
5. Remove the attached cords and controllers from the carton and place them next to the pump system. **MAKE SURE THE CORDS AND CONTROLLERS DO NOT FALL INTO THE SUMP PIT.**
6. Loosen the hose clamps on the no-hub coupling and slide the coupling up on the discharge pipe. Slightly tighten the upper hose clamp.
7. Inspect all of the screws on the hose clamps of the no-hub couplings (primary and backup

pumps). They should be tight.

8. Lift the combination system by the handle on the primary pump and lower it into the sump pit. Make sure it is level.
9. Inspect the two float switches. They should both be vertical.
10. Position the top of the pump system pipe so that it is directly below the discharge pipe. Connect the system with the no-hub coupling, and tighten the upper and lower hose clamps. Make sure both the discharge pipe and the system have ample overlap within the no-hub coupling.

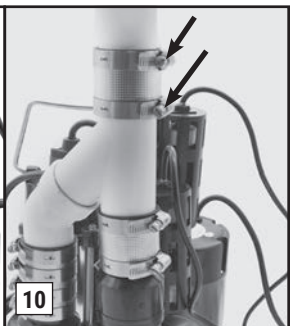
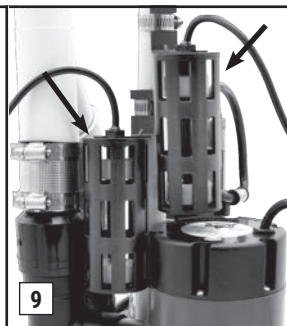
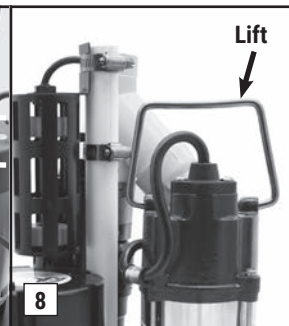
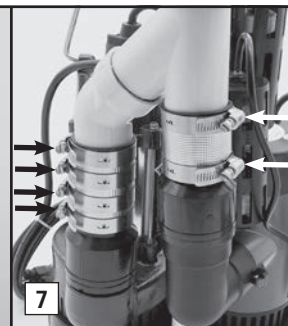
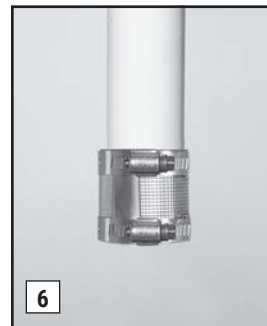
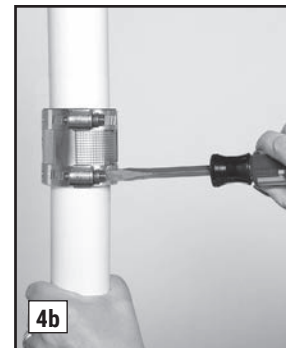
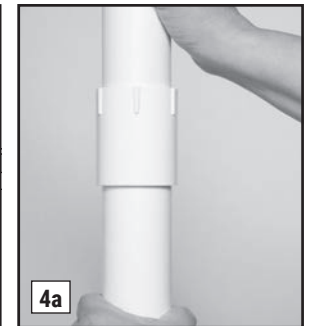
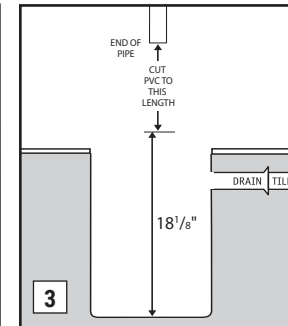
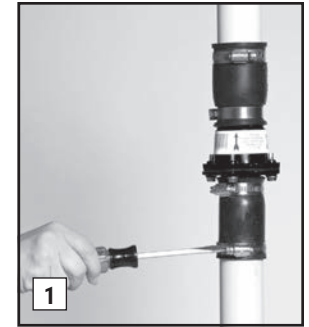

## Battery Instructions

This system will accommodate the B12-100 maintenance free (AGM) battery. To double the runtime of the backup system, two of the same model batteries can be connected together. The batteries should be of similar age. Connecting an old and new battery together will not charge properly. Specific connection instructions will be explained below.

*Note: The battery will not run the primary pump.*

### CAUTION

- The use of automotive batteries is **NOT** recommended. Automotive batteries are not designed for this application. They will only run the pump for a short time and will have a shorter life than a standby battery.
- The internal construction of some wet-cell batteries may not be compatible with this system. The use of a Pro Series B12-100 battery is **HIGHLY** recommended.

## System Connections

### ⚠ DANGER

**Risk of electrical shock or battery explosion, which can cause serious injury or death. Wear eye protection. Work in a well-ventilated area. DO NOT smoke or allow a spark or flame in the vicinity of the battery. Avoid dropping metal tools on the battery. Review the safety instructions on page 2.**

Position the backup system control unit in a secure place approximately 4' above the floor. Be sure the power cord will reach the AC power outlet, and the pump cable and the float switch will reach the bottom of the sump pit. Position the unit in a well-ventilated area. Do not place anything on top of the battery. Do not place anything on top of the control unit. (Diagram C)

1. **Connecting the backup pump:** Remove the security tag from the pump and plug the pump wires into the pump connector on the back of the control unit.
2. **Connecting the battery:** Remove the bolts from the hardware bag. Remove the security tag from the battery cables. Attach the battery cables to the battery—the RED

wire to the POSITIVE (+) bolt and the BLACK wire to the NEGATIVE (-) bolt. Screw the bolts into the battery terminals. Slide the switch on the front of the backup controller to the type of battery being used with the system.

3. **Connecting two batteries:** If you are connecting two batteries to the system, before you screw in the bolts, connect the parallel jumper cable (Model PJC) to the two batteries—the RED wires to the

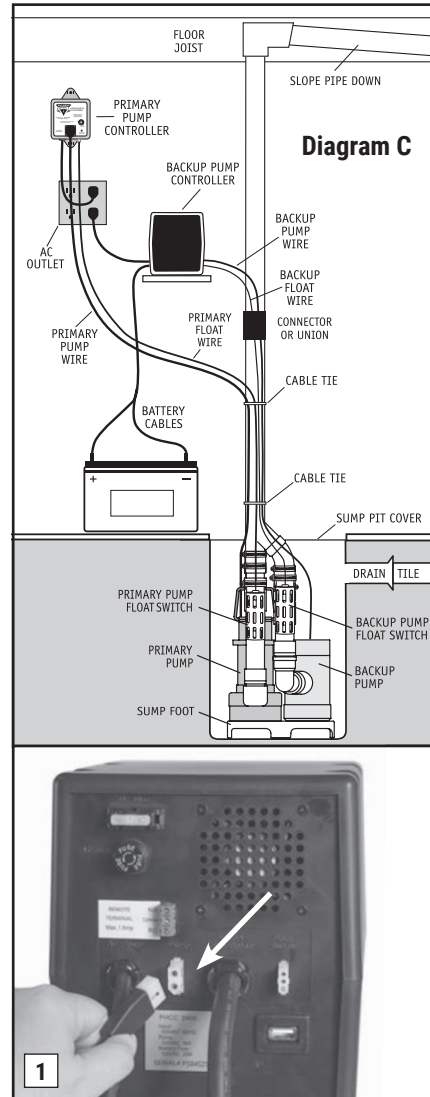

POSITIVE (+) posts and the BLACK wires to the NEGATIVE (-) posts of each battery. NEVER attach one end of the positive wire to the positive post and the other end of the positive wire to the negative post on the other battery.

4. **Connecting the backup controller:** Immediately plug the AC power cord from the backup control unit into a grounded AC wall outlet. (A surge protector that protects all three pins on the power plug is

recommended - backup system only.) You will have 10 seconds before the "Power failure" alarm will sound. The alarm will silence once the unit is plugged into the wall.

5. If any of the alarms are sounding, press the RESET button on the front of the control panel for one (1) second.
6. Secure the cover on the battery box by slipping the tabs through the fittings on the front and back of the box.

7. **Connecting the primary pump:** Mount the Enhanced controller using the 2 through holes or the zip-tie slots (ties included) located on the top and bottom tabs of the controller. The controller should be mounted at least 4' from the floor and 1' from the outlet. Plug the controller into a properly grounded 3-prong outlet. Then plug the primary pump into the receptacle on the controller. Using a flathead screwdriver, adjust the dial on the front of the controller to select the number of seconds that the primary pump will run after the float drops. The dial can be adjusted from 5-45 seconds. The manufacturer default is about 10 seconds.

8. For a neater installation, secure the cables from the controllers to the discharge pipe in several places with additional cable ties. Make sure the wires are not touching each other or overlapping each other.

9. After the initial installation, be sure to check the pump operation by filling the sump with water and observing the pump through several full cycles. The primary pump should run for 10 seconds after the lower float drops.

10. A pit cover is recommended for all installations as a safety measure, and to prevent debris from falling into the pit. Place the cover on top of the pit making sure not to pinch or crimp the pump wires with the cover. The pit cover usually has an existing hole that will allow the cords to be passed through it, or you can drill a hole in the cover.



## Product Operation

The dual float switch on the primary pump contains two large floating rings enclosed within a protective cage. Water will lift the bottom float by about ¼", which will activate the pump. If for any reason the lower float does not activate the pump, the water will rise to the second float, which will activate the pump. As the pump evacuates the water from the pit, the floats will drop. The pump will run for an additional 10 seconds to extend the cycle after the lower float drops. The blue controller for the primary pump powers this process.

During a power outage, or when more water is entering the sump than the primary pump can handle, the backup pump will automatically begin pumping. It also has a dual float switch, so if one float fails to activate the pump, the second float will activate the pump as soon as the water reaches that level. As the water recedes below the float switch, a timer in the control unit will run the pump an additional 25 seconds to empty the pit.

While the pumps are active, water will come out of the 3/16" hole that is in the check valve above the pump. This is normal. The hole is needed to prevent an air lock within the system. Do not obstruct this hole or an air lock may prevent the pump from evacuating water, and the basement will flood.

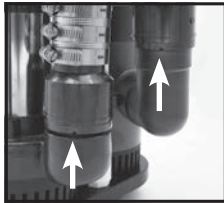

Batteries and sump pumps need maintenance. The control unit on the backup system monitors the battery and power conditions, and sounds an alarm when maintenance is required. Following is an explanation of the warnings and alarms.

## Understanding the Warning Lights and Alarms

The Pro Series control unit features a series of warning lights that pinpoint potential problems. In addition, an alarm sounds to alert you to the problem. In some cases the lights and alarm will go off automatically when the problem has been solved. In others, the RESET button must be pushed to silence

the alarm. Refer to the table below for a quick review of the features and their corresponding alarm status.

Warning	Alarm can be silenced before problem is corrected	Alarm shuts off automatically when problem is corrected
Battery problem	No	No, push RESET button
Power or AC fuse failure	Yes	Yes
Pump or DC fuse failure	No	No, push RESET button
Pump was activated	Yes	No, push RESET button

## SILENCING THE ALARM DURING AN EMERGENCY

If the alarm can be silenced before the problem is corrected, you may silence it for two (2) minutes by holding down the RESET button for one (1) second. The alarm will be silenced, but the light will stay on. To silence the alarm for 24 hours, hold down the RESET button for five (5) seconds. It will automatically reset itself after 24 hours. The warning light will stay on.

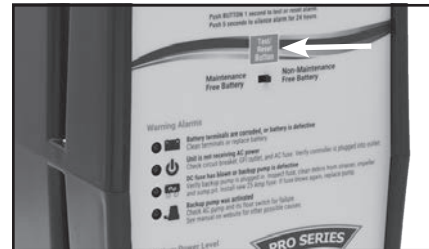

### ① The battery terminals are loose or the battery is defective

This light and alarm will come on when the control unit detects the battery has less than one-half (½) hour of pumping power left, or that the battery is defective. The alarm cannot be silenced because action needs to be taken to protect your basement. If your battery is more than five (5) years old, replace it. If not, here are several situations that would cause the pump to run the battery for an extended time and discharge the battery: Check the following list



before you replace the battery.

- If the 2nd light on the controller is also on, it means that the unit is not receiving AC power and is unable to charge the battery. Either the AC power is out, the circuit breaker has blown, or the outlet is bad. When the problem is corrected, the battery should recharge.
- If the 4th light on the controller is also on, check your main pump for failure. The backup pump may have been activated repeatedly if your main AC pump is broken, or you are experiencing heavy rains and your main pump cannot keep up with the inflow of water. You may need to upgrade or replace your main pump. When the problem is corrected, the battery should recharge.
- If no other lights are on, this means the terminals may be corroded, and the battery cannot charge properly. Unplug the control unit from the wall outlet. Then, check the battery cables and the battery posts for corrosion. Clean and tighten them as needed. For step-by-step instructions on how to do this, See the Replacing the Battery section at the top of the following page.
- If you are using a maintenance-free battery, the terminals will not corrode. However, the connections may be loose. Tighten the bolts on the battery posts.
- If the battery posts have been cleaned and

the light is still on, the issue could be the controller or the battery. The best way to determine if the battery is the problem is to have it charged and load tested at any local auto supply or battery store. If the battery is bad and less than one (1) year old, it can be returned to the place of purchase for a replacement (receipt required). If the battery is good, contact Glentronics' service department for further instructions. The phone number is 800-991-0466.

If the battery alarm goes on while the pump is running and the power is out, you will have a minimum of one-half (½) hour of continuous pumping time to replace the battery. (In most cases, the pump does not run continuously, and therefore, you actually have a longer time to replace it.) You will not be able to silence the alarm. Left unattended, the basement will flood. In a severe emergency, if a replacement battery is not available, you could temporarily use your car battery, or recharge this battery by connecting it to your car battery.

Once the AC power is restored, the battery will recharge automatically, unless it is old or damaged. The alarm will remain on until the RESET button is pressed for one (1) second.

In the event that your Pro Series sump pump system has pumped for an extended period of time, the battery may be very depleted. In this condition, when the AC power is returned to the unit, a battery alarm will continue to sound. The battery may need a longer period to recharge. Press the RESET button for five (5) seconds to silence the alarm.

If the battery is completely discharged, an internal safety feature will not allow the charging system to activate. Call the Glentronics' service department for instructions or replace the battery.

## REPLACING THE BATTERY

### ⚠ DANGER

**Risk of electrical shock or battery explosion, which can cause serious injury or death. Wear eye protection. Work in a well-ventilated area. DO NOT smoke or allow a spark or flame in the vicinity of the battery. Avoid dropping metal tools on the battery. Review the safety instructions on page 2.**



**REFER TO THE PHOTOS BELOW**

1. Unplug the power cord from the wall outlet.
2. Remove the cover of the battery box by pushing in the tabs on the front and back, then lifting up.
3. Fan the area around the top of a vented battery with a piece of cardboard (or another nonmetallic material) to remove any hydrogen or oxygen gas that may have been emitted from the battery.
4. Loosen the bolts and remove the battery cables. Remove the old battery from the battery box and place the new battery in the box.
5. Clean any corrosion off of the ring connectors on the ends of the battery wires. Use a stiff brush or sandpaper. **DO NOT** apply corrosion-resisting sprays or pads to the terminal rings or bolts after you have cleaned them, as this could prevent the battery from charging properly.
6. Replace the battery cables, RED to the POSITIVE (+) post and BLACK to the NEGATIVE (-) post. Tighten the bolts.
7. Plug the power cord back into the wall outlet. (You should provide additional

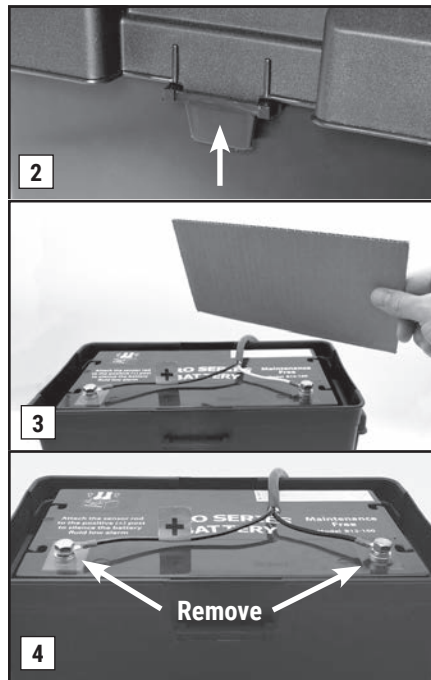

protection for the backup control unit by using a surge protector.)

8. Replace the cover on the battery box.
9. If any of the alarms are sounding, press the RESET button on the front of the control panel for one (1) second.

**CLEANING BATTERY TERMINALS**

Refer to REPLACING THE BATTERY (page 6) follow the same steps without swapping out the battery as stated in step 4.

**② The unit is not receiving AC power**

Power failure can have several causes. The most common is a power outage by your electric company. During this emergency, the Pro Series system will automatically switch to battery power and protect your basement from flooding.

You can silence the "AC power failure" alarm for 24 hours by pressing the RESET button for

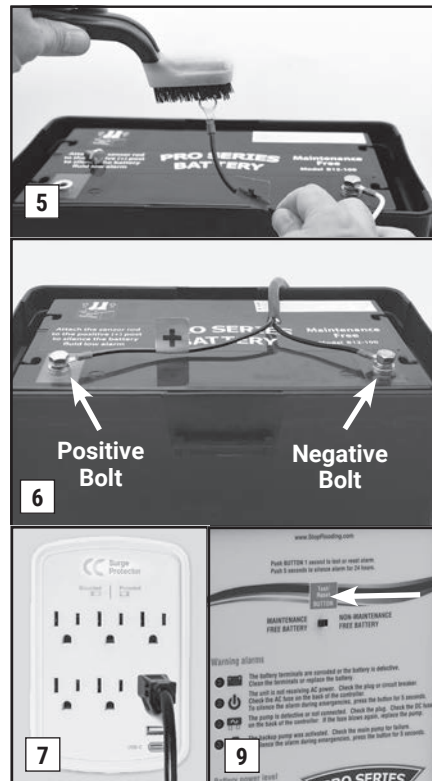

five (5) seconds. The alarm will be silenced, but the light will stay on. The system will continue to operate while the power alarm is silenced. After 24 hours, the alarm will reset automatically.

1. If the power is on in the rest of the house, check the home circuit breaker or fuse box for failure, and correct the problem.
2. Check the power cord. Make sure it is securely plugged into the wall outlet. Make sure the outlet is working properly.
3. The control unit may have received a power surge. (a) Check the AC fuse located on the back panel of the control unit. First, unplug the control unit from the wall outlet. To check the barrel fuse, push it in and turn it counter-clockwise then pull it out to see if the wires in the fuse are intact. (b) If the wires are burned and broken, replace the fuse with a 5 Amp glass-barrel fuse, commonly found at hardware stores and auto supply stores. Replace the fuse by pushing it in and turning clockwise. Plug in the control unit. (You should provide additional protection for the control unit by using a surge protector.) If the fuse blows again, call Glentronics technical support at 800-991-0466.

The control unit must receive 115 volts AC +/- 5% from the AC outlet. Voltage lower than 110 volts will activate the power failure alarm. Lower voltages can be caused by utility company brownouts or a heavy power

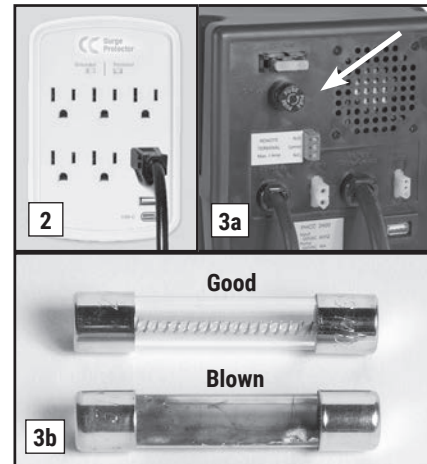

draw from other appliances on the same circuit. Reduce the number of appliances on the circuit.

**③ DC fuse blown or backup pump defective**

**⚠ DANGER**

**Unplug the main AC pump before servicing the backup pump to avoid electric shock. Failure to do so could cause serious injury or death.**

**REFER TO THE PHOTOS BELOW**

The Pro Series control unit will check the pump and its wire connections each week for possible pump failure. The system will test the pump by running it for 2-3 seconds to make sure it is operating. The test will not trigger an alarm. If the "Pump or DC fuse" alarm sounds:

1. Check the pump plug in the back of the unit to make sure it is firmly connected. Check the pump wires to make sure they are connected securely to the pump plug. Check the rest of the pump wires for any possible breaks.
2. If the pump wires are intact, the pump may be clogged. (a) Disconnect both control units from the wall outlet, and disconnect the battery cables. (b) Release the no-hub coupling, and remove the pumps from the sump pit. (c) Rinse any debris from the strainer, and then reconnect the pumps to the discharge pipe. (d) Connect the control unit, and the battery cables to the battery—the

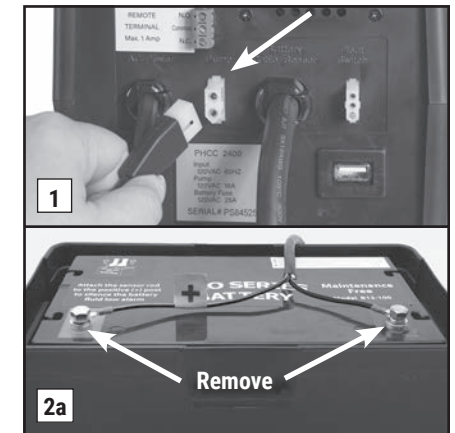

RED wire to the POSITIVE (+) post and then the BLACK wire to the NEGATIVE (-) post. Tighten the bolts on the battery posts. (e) Plug the control unit back into the wall outlet.

- (a) Check the DC fuse by pulling it out of the fuse holder. (b) If the wires are burned and broken, replace the fuse with a 25 Amp DC safety fuse. If the fuse blows again, unplug the computer control unit from the wall and disconnect the battery cables from the battery. Then call Glentronics technical support for instructions at 800-991-0466. You may need to replace the pump.

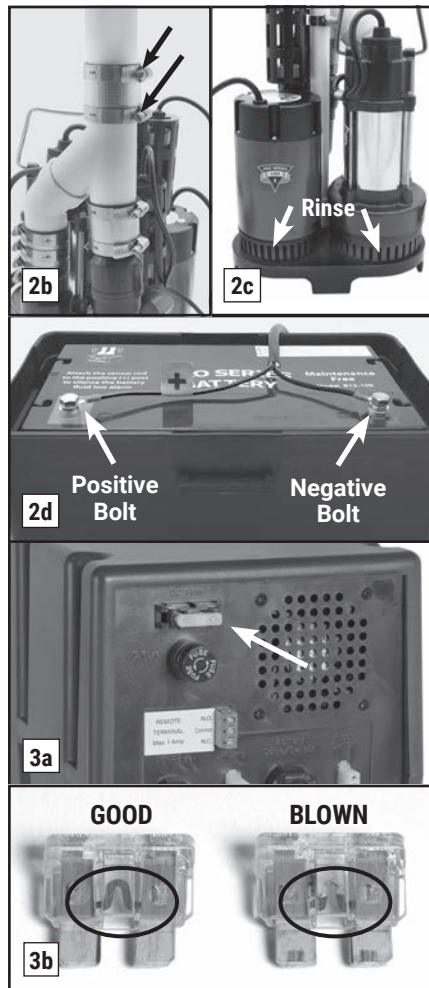

- Plug the main AC pump back into the wall outlet.

#### ④ The pump was activated

When water rises in the sump pit and lifts the float switch, the pump will begin pumping, and the "Pump was activated" light and alarm will turn on. The pump warning stays on to alert you that the standby system was used to empty the water from the sump pit. Try to determine what caused the system to activate.

- Check the main pump for failure. It may not be working, the float switch may be stuck, or it may be too small to handle the inflow of water.
- Make sure the check valve is working. It may need to be replaced.
- Make sure the discharge pipe is not clogged or frozen.
- If the power was out, the backup pump was automatically activated. You need to push the RESET button to silence the alarm.

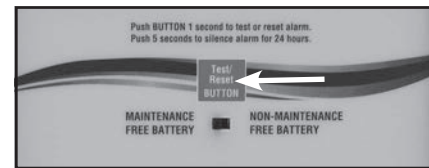

#### REPLACING THE BACKUP PUMP

Before you begin this process, you will need a new backup pump, new check valves, and new wire ties. The check valves have a 1½" MPT on one end, and a 1½" SLIP on the other end. The check valves also have a pre drilled 3/16" air bleed hole. The 3/16" air bleed hole is required to help prevent an air lock within the system. See page 12 for part numbers.



**⚠ DANGER**  
**Risk of electrical shock or battery explosion, which can cause serious injury or death. Wear eye protection. Work in a well-ventilated area. DO NOT smoke or allow a**

**spark or flame in the vicinity of the battery. Avoid dropping metal tools on the battery. Review the safety instructions on page 2.**

**YOU WILL BE DISCONNECTING ALL THE WIRES. BE SURE THEY DO NOT FALL INTO THE SUMP PIT.**

- Unplug the primary pump, the blue controller, and the power cord for the backup pump control unit from the wall outlet.
- Unplug the backup pump from the back of the backup control unit.
- Remove the cover of the battery box and fan the area around the top of a vented battery with a piece of cardboard (or another nonmetallic material) to remove any hydrogen or oxygen gas that may have been emitted from the battery.
- Remove the battery wires from the battery posts. Be sure they do not touch each other while one is connected to the battery.
- Slowly loosen the no-hub coupling on the top of the combination pump assembly to separate the pipes. The water trapped in the pipe will pour out into the sump as the no-hub coupling is loosened.
- Separate the pump assembly from the no-hub coupling and lift it out of the sump pit by the handle on the primary pump. Tip the assembly over the sump pit to drain away any remaining water.
- Lay the pumps down and remove the screws attaching the backup pump to the sump foot.
- Loosen the hose clamps on the no-hub connectors on both pumps.
- Ease the wye assembly off of the pumps.
- Unscrew the pipe adapter from the backup pump.
- While you have the pump apart, this would be a good time to replace the check valves. Contact Glentronics, Inc. to order check valves with a 1½" MPT on one end, a 1½" SLIP on the other end and a pre drilled 3/16" air bleed hole (#1141007). The 3/16" air bleed hole is required to help prevent an air lock within the system.

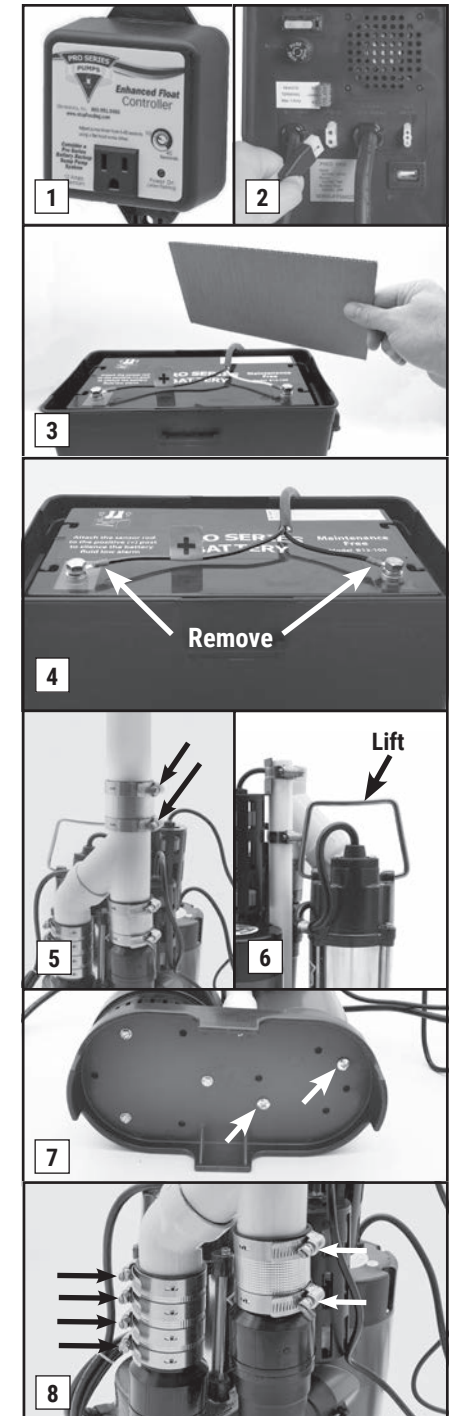



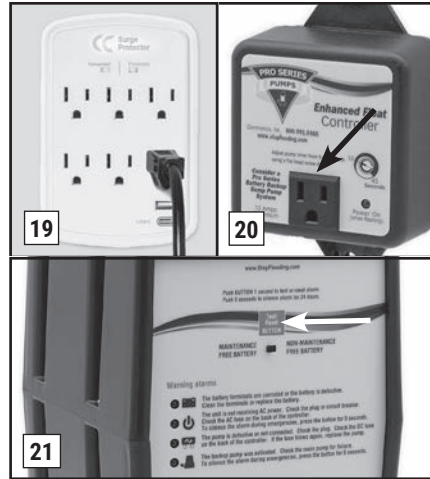
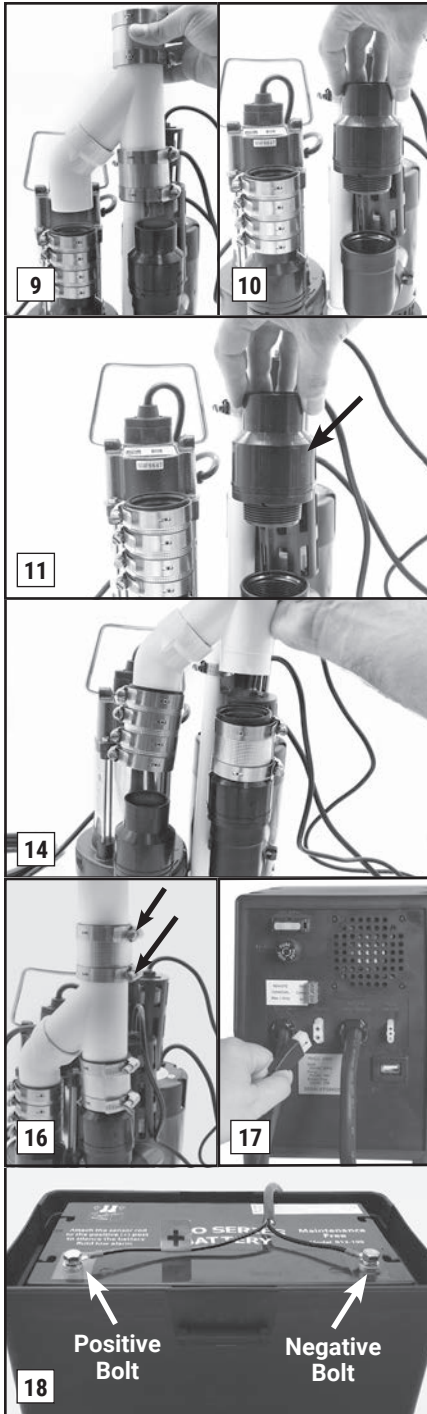

12. Now, reverse the process. Replace the pump by first screwing the adapter assembly into the new pump.
13. Screw the pump to the pump stand.
14. Ease the wye assembly back onto the check valves, and tighten the hose clamps.
15. Lower the pumps into the sump pit by the handle on the primary pump.
16. Ease the wye assembly back into the no-hub coupling on the discharge pipe and tighten the hose clamps.
17. Connect the backup pump to the back of the backup control unit.
18. Connect the battery wires to the battery bolts, RED to the POSITIVE (+) post and BLACK to the NEGATIVE (-) post. Replace the cover on the battery box.
19. Plug the power cord from the backup control unit into the outlet. You should provide additional protection for the system by using a surge protector.
20. Plug the primary pump into the receptacle on the blue Enhanced controller and then plug the power cord from the controller into the wall outlet.
21. If any of the alarms are sounding, press the RESET button for 1 second.
22. After the backup pump is replaced, be sure to check the pump operation by filling the sump pit with water and observing the pump through several full cycles.

## REPLACING THE PRIMARY PUMP

Before you begin this process, you will need a new AC pump, new check valves, and new wire ties. The check valves have a 1½" MPT on one end, and a 1½" SLIP on the other end. The check valves also have a pre drilled 3/16" air bleed hole. The 3/16" air bleed hole is required to help prevent an air lock within the system. See page 12 for part numbers.



### **⚠ DANGER**

**Risk of electrical shock or battery explosion, which can cause serious injury or death. Wear eye protection. Work in a well-ventilated area. DO NOT smoke or allow a spark or flame in the vicinity of the battery. Avoid dropping metal tools on the battery. Review the safety instructions on page 2.**

***YOU WILL BE DISCONNECTING ALL THE WIRES. BE SURE THEY DO NOT FALL INTO THE SUMP PIT.***

1. Unplug the primary pump, the blue controller, and the power cord for the backup control unit from the wall outlet.
2. Unplug the backup pump from the back of the backup control unit.
3. Remove the cover of the battery box and fan the area around the top of a vented battery with a piece of cardboard (or another nonmetallic material) to remove any hydrogen or oxygen gas that may have been emitted from the battery.
4. Remove the battery wires from the battery posts. Be sure they **DO NOT** touch each other while one is connected to the battery.
5. Slowly loosen the no-hub coupling on the top of the combination pump assembly to separate the pipes. The water trapped in the pipe will pour out into the sump as the no-hub coupling is loosened.
6. Lift the pump assembly out of the pit by the handle on the primary pump. Tip the assembly over the sump pit to drain any remaining water.

7. Lay the pumps down and remove the three (3) screws holding the primary pump to the sump foot. The strainer on the primary pump will separate from the pump when the screws are removed. **SAVE THESE SCREWS** or replace them with #10-24 x 1½" stainless-steel screws.
8. Loosen the hose clamps on the no-hub connector on top of the primary pump and

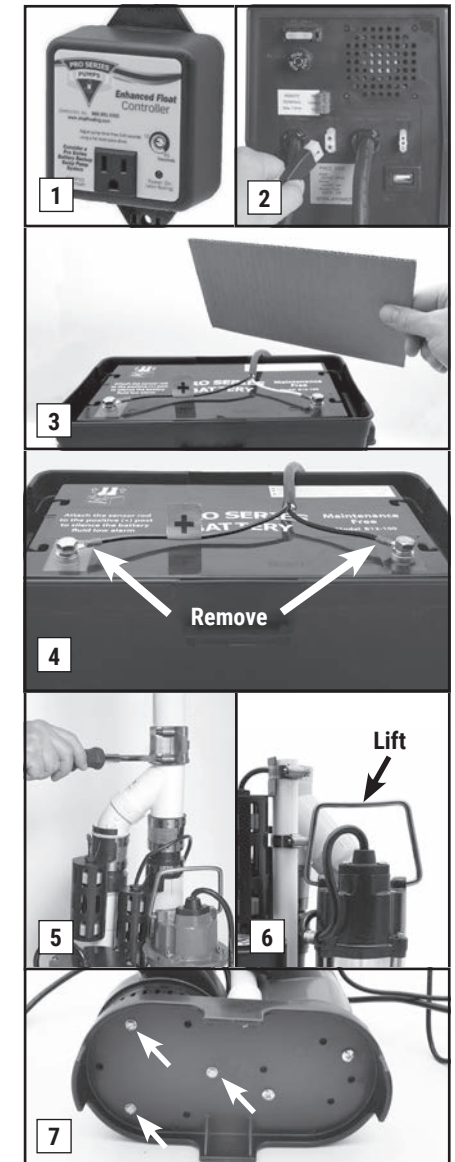

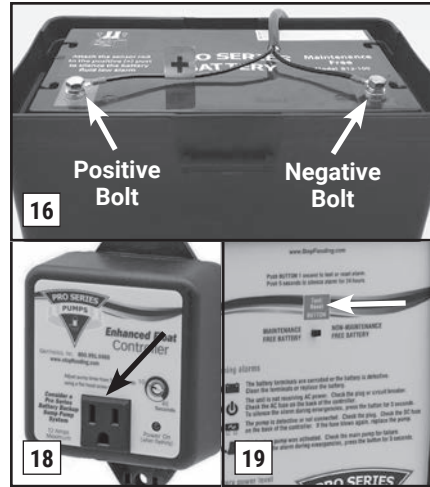
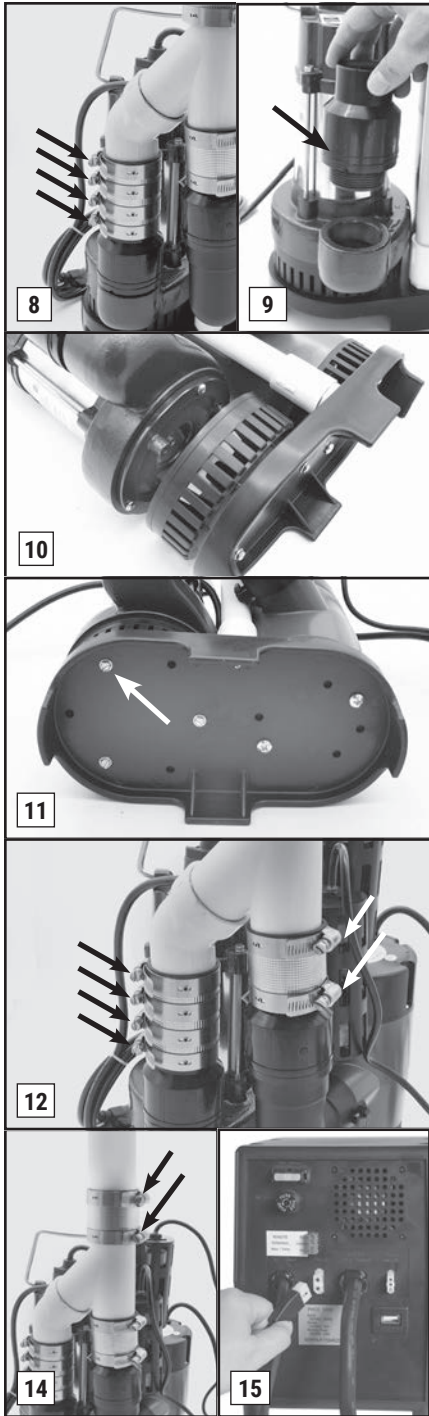

ease the pump out of the connector. You may need to loosen the hose clamps on the backup pump.

9. While you have the pump apart, this would be a good time to replace the check valves. Contact Glentronics, Inc. to order check valves with a 1½" MPT on one end, a 1½" SLIP on the other end and a pre drilled 3/16" air bleed hole (#1141007). The 3/16" air bleed hole is required to help prevent an air lock within the system.
10. Remove the screws from the strainer on the new primary pump and discard them before you place it on the sump foot. You will need to thread the old screws through the foot, the strainer and into the pump.
11. Line up the discharge pipes parallel to each other and start with the top screw. Once the top screw is replaced, the other screws will line up with the holes. Tighten all the screws.
12. Ease the pump back into the no-hub connector and tighten the hose clamps.
13. Lower the pump back into the pit by the handle of the primary pump.
14. Connect the top of the system to the no-hub coupling and tighten the hose clamp.
15. Connect the backup pump to the back of the backup control unit
16. Connect the battery wires to the battery posts, RED to the POSITIVE (+) post and

17. BLACK to the NEGATIVE (-) post. Replace the cover on the battery box.
17. Plug the power cord from the backup control unit into the outlet. You should provide additional protection to the system by using a surge protector.
18. Plug the primary pump into the receptacle on the blue Enhanced controller and then plug the power cord from the controller into the wall outlet.
19. If any of the alarms are sounding, press the RESET button for 1 second.
20. After the primary pump is replaced, be sure to check the pump operation by filling the sump pit with water and observing the pump through several full cycles.

### ⑤ Battery power level

Your Pro Series combination sump pump system has a gauge which will report the level of charge remaining in the battery. As the battery's energy is depleted during operation without AC power or simply by aging, the gauge will indicate the percent of charge remaining in the battery. Should the level drop below 25%, the "Battery problem" indicator will light up and the alarm will sound.

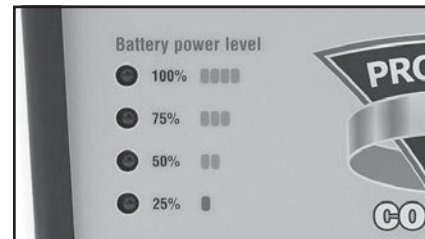

## Remote Notification

### THE REMOTE TERMINAL

The Pro Series 2400 can be connected to a home security system or other alarm devices to alert you to a problem or required maintenance.

### INSTRUCTIONS FOR CONNECTING A REMOTE ALARM

The terminal is located on the back of the control unit. There are three (3) positions

for wire connections on the terminal: N.C. (Normally Closed), N.O. (Normally Open), and Common.

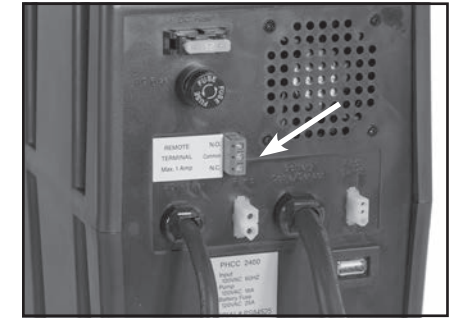

Check your security system or alarm to determine whether an open (no contact) or closed (making contact) connection is needed to activate the alarm.

The security system will provide two connection terminals. You will need to extend wires from the security system to the Pro Series control unit. Strip the two wires, ¼" each. Connect either wire to the common terminal. To secure the wire into the terminal, insert the exposed wire into the hole on the back of the terminal next to the screw marked Common. Turn the screw a few turns to lock in the wire.

If the security system requires a closing of a contact to activate the alarm, secure the other wire in the terminal hole labeled N.O. (Normally Open). If the security system requires an opening of a contact, secure the wire in the terminal hole labeled N.C. (Normally Closed).

### USB DATA PORT

This system has been updated with a USB port on the back of the controller. The purpose of this port is to allow communication with the Pro Series CONNECT Module. **DO NOT** connect any other device to the USB data port other than a Pro Series Wifi CONNECT Module.





## CONNECT MODULE



The Pro Series CONNECT Module is a separately sold accessory that will allow the user to stay connected and receive remote notifications of potential problems and needed maintenance while away from home.

### Pro Series WiFi Module (Model PS-WiFi2)

- Sends texts, emails or push notifications and status alerts to your phone, tablet or computer
- No required monthly or yearly fees or subscriptions



Model PS-WiFi2

For more information, please visit [www.StopFlooding.com](http://www.StopFlooding.com)

## TESTING THE FLOAT SWITCH FOR THE BACKUP PUMP

*It is important to manually test the float switches periodically or after any maintenance.*

### ⚠ DANGER

**Unplug the main AC pump when installing or servicing the backup pump to avoid electric shock. Failure to do so could cause serious injury or death. Review the safety instructions on page 2.**

Lift the float up with a pencil, or another nonmetallic item, and let go. This will activate the pump. The control unit will run the pump for approximately 25 seconds so it can empty all the water in the sump pit. If no water is in the pit, the pump can run dry for this amount of time. The alarm will sound and the "Pump was activated" light will go on. After the pump has stopped, push the RESET button to silence the alarm. If the RESET button is

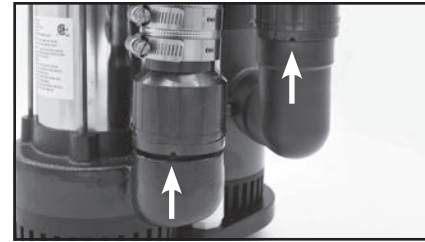
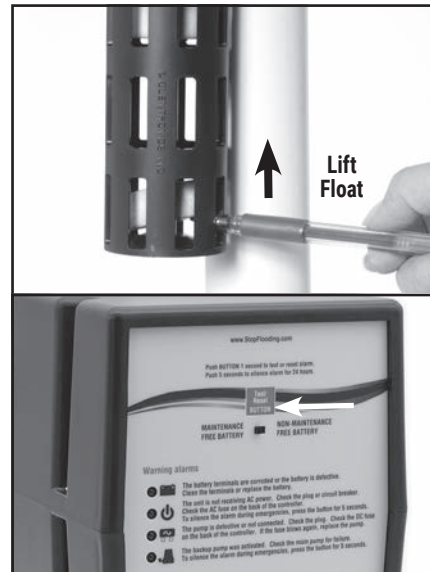

pressed before the pump has stopped, the alarm will go off temporarily. Wait for the pump to stop pumping, and then push the RESET button on the front of the control unit to completely silence the alarm.

While the pumps are active, water will come out of the  $\frac{3}{16}$ " hole that is drilled in the check valve above the pump. This is normal. The hole is needed to prevent an air lock within the system. **DO NOT** obstruct this hole or an air lock may prevent the pump from activating, and the basement will flood.

**BE SURE TO PLUG IN THE MAIN AC PUMP WHEN YOU HAVE COMPLETED THE TEST.**

## TESTING THE FLOAT SWITCH FOR THE PRIMARY PUMP

Lift the float up with a pencil, or another nonmetallic item, and let it go to activate the pump. The pump will run an additional 10 seconds after the float returns to the original position. It will not damage the pump to run it for this short time if the sump pit is dry. However, **DO NOT** hold the float up for an extended time without water in the sump pit.

While the pumps are active, water will come out of the  $\frac{3}{16}$ " hole that is drilled in the check valve above the pump. This is normal. The hole is needed to prevent an air lock within the system. **DO NOT** obstruct this hole or an air lock may prevent the pump from activating, and the basement will flood.

## MAINTENANCE CHECKLIST

Maintenance should be performed 1-2 times per year.

1. Lift the float switches on both pumps as described to the left.
2. Remove all debris from the bottom of the pit and pump strainer.
3. Remove all debris floating in the water.
4. Remove all debris from the float switch cage.
5. Fill the pit with water. Make sure the pumps turn on at the intended levels.
6. While the pump is running, make sure the pump is evacuating water at a good pace and water is coming out of the  $\frac{3}{16}$ " air bleed hole.
7. Check and clean battery and terminals.

## PARTS & SERVICE INFORMATION

You can receive technical support, parts, or service information by calling Glentronics, Inc., at **800-991-0466** or by visiting the Pro Series website at [www.stopflooding.com](http://www.stopflooding.com). Send your unit to the following address if repairs are needed:

Glentronics, Inc.  
Attn: Service  
645 Heathrow Drive  
Lincolnshire, IL 60069-4205



# Replacement Parts List

## PS-C50 Description

## Part

Controller for backup pump	PHCC-2400-CONT
Enhanced dual float switch with controller for AC pump	DFC1.5
½ HP AC sump pump	S3050-NS
PHCC-2400 backup pump	1011013
Battery box	1113003
PVC wye pipe and 45° elbow	1120017
Sump foot	1143000
Instructions	1806193
Stainless-steel screw, #10-24 x 1½" *	1100021
#14 x ¾" pan-head screws	1100024
Caged dual float switch	FLOAT-DLCH
Stainless-steel hose clamp, 2½" diameter *	1122002
Check valve, 1½" MPT x 1½" SLIP with weep hole*	1141007
No-hub coupling, 1½" *	1142000
No-hub coupling (long)	1142004

\*Stock items available in plumbing department

Call 800-991-0466 to order parts.

## TOP VIEW

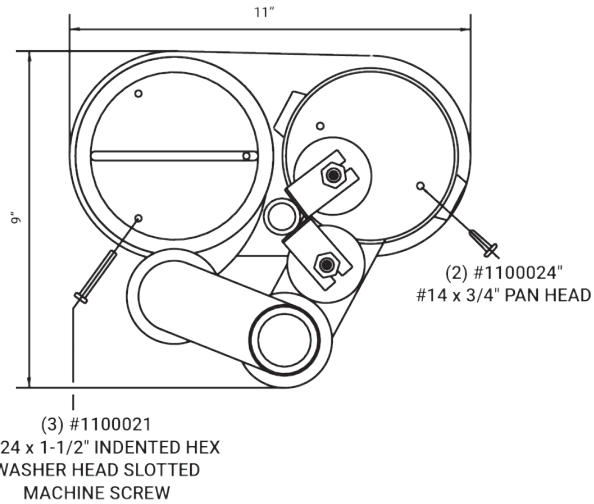

PHCC – 2400 – CONT – OP AMP

DFC1.5

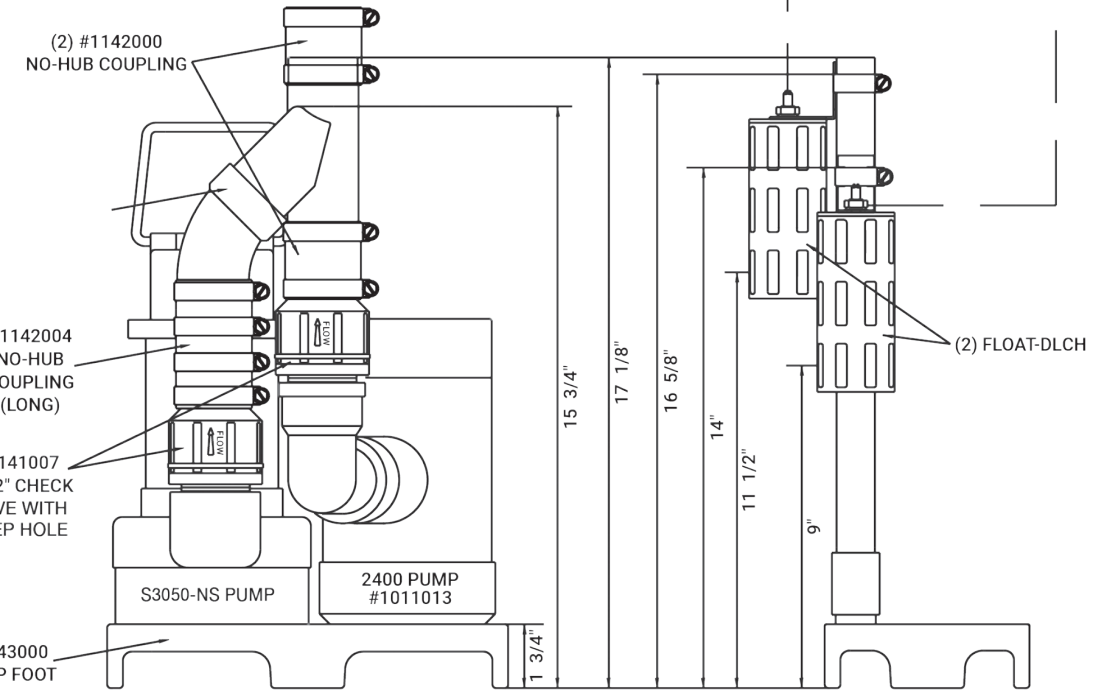
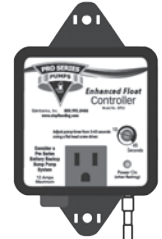
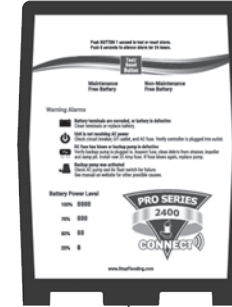

## SIDE VIEW

## FLOAT STICK

## Primary Pump Troubleshooting Guide

### **⚠ DANGER**

Read safety warnings & instructions before attempting any repairs or maintenance.

Potential Cause	THE PUMP WILL NOT START OR RUN	Solutions
Pump is not plugged in	Plug pump in properly (see instructions)	
No AC power	Check circuit breaker or fuse, and GFI reset button	
Poor power source	Check circuit line wires, cable and outlet	
Float switch wire is not connected to the controller	Check connection of float switch wire to the controller	
Locked impeller	Remove strainer and clear obstruction	
Defective float switch	Replace float switch with new float switch	
Defective pump	Replace pump with new pump	

### **Potential Cause THERMAL PROTECTOR TRIPPING OR NOT FUNCTIONING Solutions**

Locked impeller	Remove strainer and clear obstruction
Incorrect power supply	Check power supply source and voltage
Pump running continuously with no water present	Check float switch

### **Potential Cause PUMP STARTS AND STOPS TOO FREQUENTLY Solutions**

Float switches mounted too low	Raise both float switches
Water back flowing from pipe	Install or replace check valve
Malfunctioning float switch	Replace float switch with new float switch

### **Potential Cause PUMP WILL NOT SHUT OFF Solutions**

Clogged or frozen discharge	Clear blockage or thaw frozen line
Blocked intake strainer	Clear debris from intake strainer
One or both of the floats is obstructed and cannot drop down	Clear debris from inside the float cage (Loosen nut on top of float, then remove c-clip on bottom of float. Remove debris. Tighten nut on top of float, then replace c-clip on bottom of float.) When reassembling the float, the magnetic strip on the inside of the float should be facing down.
Defective float switch	Replace float switch with new float switch
Check valve is stuck	Replace check valve

### **Potential Cause INSUFFICIENT OR NO WATER VOLUME Solutions**

Check valve on secondary pump will not close and water recirculates within the system	Replace the check valve on the secondary pump
Partially blocked impeller	Remove strainer and clear obstruction
Clogged or frozen discharge pipe	Clear blockage or thaw frozen line
Broken or leaking pipe	Repair pipe
Low power voltage	Check power voltage, wires and cable condition
Check valve is stuck	Replace check valve.
There is an air lock in the system	Make sure the 3/16" air bleed hole located on the check valve is clear of debris

### **Potential Cause ABNORMAL SOUND OR VIBRATION Solutions**

Check valve is broken	Replace the check valve
Blocked intake screen	Clear debris from intake screen
Defective pump	Replace pump

## Backup Pump Troubleshooting Guide

### **⚠ DANGER**

Read safety warnings & instructions before attempting any repairs or maintenance.

Potential Cause	BATTERY PROBLEM	Solutions
Terminals are corroded	Clean terminals and cables	
Cables are loose	Tighten wing nuts or bolts	
Battery is discharged below 25%	Replace battery if power is out. Only 1 hour of continuous pumping power is left. Battery will recharge when power is restored	
Battery is old or damaged	Replace battery	

### **Potential Cause POWER FAILURE Solutions**

Power outage	None. The backup pump will run off of the battery
An outlet, fuse, or circuit breaker has failed	Try another outlet, replace the fuse, or reset the circuit breaker
The charger is unplugged from the wall	Make sure the power cord is plugged in securely
The control unit is receiving less than 110 volts from the outlet	None, if the utility company has instigated brownouts. Otherwise, reduce the number of other appliances on the circuit
Backup pump is unplugged	Make sure the pump is securely plugged into the back of the control unit

### **Potential Cause PUMP WILL NOT SHUT OFF Solutions**

Backup pump is clogged	Remove strainer from pump and clean out any debris
Backup pump is broken	Replace the pump
The check valve is stuck and the water cannot pass through it	Replace the check valve
The discharge pipe is clogged or frozen and the water cannot pass through it	Thaw, clean out the blockage, or replace the discharge pipe
There is an air lock in the system	Make sure the 3/16" air bleed hole located near the top of the PVC pipe is clear of debris

### **Potential Cause PUMP ACTIVATED ALARM Solutions**

The main AC pump failed because of a power outage	None. The backup pump was activated when needed
The water was coming into the sump faster than the main pump could evacuate it	None. The backup pump was activated when needed
The float switch on the main AC pump is stuck or defective	Free the float switch on the main pump or replace it
The main AC pump is broken	Replace the main AC pump
The main AC pump could not keep up with the inflow of water	None. The backup pump was activated as needed. If this is a recurring problem, install a higher-capacity main pump
There is a slight chance of false activation if the float switch cord is wrapped around the AC power cord	Move the float switch cord away from the AC power cord

### **Potential Cause ABNORMAL SOUND OR VIBRATION Solutions**

Check valve is broken	Make sure check valve is functioning, or replace it
Blocked intake screen	Clear debris from intake screen
Defective pump	Replace pump

If the listed solutions do not resolve the problem, follow the instructions within the manual to disconnect the system from the outlet and battery terminals, then reconnect the system and push the reset button. If the problem continues, contact Glentronics customer service at 800-991-0466.

## Limited Warranty

By opening this package and using this GLETRONICS, INC. product, you are agreeing to be bound by the terms of the GLETRONICS, INC. limited warranty ("warranty") as set out below. Do not use your product until you have read the terms of the warranty. If you do not agree to the terms of the warranty, do not use the product and return it within the return period stated on your purchase receipt from the retail store or authorized distributor where you purchased it for a refund.

To the extent permitted by law, this warranty and the remedies set forth are exclusive and in lieu of all other warranties, remedies and conditions, whether oral, written, statutory, express or implied. GLETRONICS, INC. disclaims all statutory and implied warranties, including without limitation, warranties of merchantability and fitness for a particular purpose and warranties against hidden or latent defects, to the extent permitted by law. GLETRONICS, INC. will not be liable for any incidental, special or consequential damages for breach of any express or implied warranties on this product. In so far as such warranties cannot be disclaimed, GLETRONICS, INC. limits the duration and remedies of such warranties to the duration of this express warranty and, AT GLETRONICS, INC.'s option, the repair or replacement services described below. Some states (countries and provinces) do not allow limitations on how long an implied warranty (or condition) may last, so the limitation described above may not apply to you.

Any and all causes of action arising from, filed as a result of or in reference to, this warranty or the products described under this warranty shall be governed by and construed under the laws of the State of Illinois. Any cause of action arising from, filed as a result of or in reference to, this warranty or the products described under this warranty shall be filed only in the Circuit Court of the 18th Judicial District, Lake County, Waukegan, Illinois, or in the Northern District of Illinois if filed in Federal Court. The maximum liability for any product described in this warranty shall be the cost of product replacement only.

If any term is held to be illegal or unenforceable, the legality or enforceability of the remaining terms shall not be affected or impaired.

### What is Covered by this Warranty?

GLETRONICS, INC. warrants to the end purchaser that its pumps, switch and control unit products are free from defective materials and workmanship for the periods indicated below:

All parts and labor (excluding installation) for a period of:

- 4 years from the date of installation, when purchased and installed by a contractor; otherwise, 3-year warranty applies when used intermittently as a sump pump.

The defective product must be returned directly to the factory, postage prepaid with the original bill of sale or receipt to the address listed below. GLETRONICS, INC., at its option, will either repair or replace the product and return it postage prepaid.

### What is NOT Covered by this Warranty?

This warranty does not cover the cost or value of damaged property, including expressly any property that has been affected by water overflow, seepage or flooding. If GLETRONICS, INC. determines that a product is deemed defective under this warranty agreement, it will repair or replace the PRODUCT ONLY. GLETRONICS, INC. will not cover the cost to reinstall the product, nor will GLETRONICS, INC. pay the cost of having a plumber or contractor repair or replace the product.

GLETRONICS, INC. will not repair or replace a product that was installed incorrectly. A product shall be considered "installed incorrectly" when it deviates in any way from the instructions described in this manual.

This warranty does not cover product problems resulting from handling liquids hotter than 104 degrees Fahrenheit, handling inflammable liquids, solvents, strong chemicals or severe abrasive solutions; user abuse; misuse, neglect, improper maintenance, commercial or industrial use; improper connection or installation, damages caused by lightning strikes; excessive surges in AC line voltage; water damage to the controller; other acts of nature, or failure to operate in accordance with the enclosed written instructions.

### How to Obtain Warranty Service

Within thirty (30) days of the product's defective performance, the unit must be shipped, freight prepaid, or delivered to GLETRONICS, INC. to provide the services described hereunder in either its original carton and inserts, or a similar package affording an equal degree of protection. Products not received by GLETRONICS, INC. at the address indicated below within thirty (30) days of the product's defective performance will not be considered for warranty service. Products received after three (3) years from the date of purchase, fall outside of the timeframe for warranty service and will not be eligible for warranty service. The product must be returned to GLETRONICS, INC. for inspection in order to be considered for warranty service. If the product is not returned to GLETRONICS, INC. or the product is inspected by any person, plumber, contractor or business other than GLETRONICS, INC., this warranty shall no longer be valid. Prior to defective operation, the unit must not have been previously altered, repaired or serviced by anyone other than GLETRONICS, INC., or its agent; the serial number on the unit must not have been altered or removed; the unit must not have been subject to accident, misuse, abuse or operated contrary to the instructions contained in the accompanying manual. The dealer's dated bill of sale, or installer's invoice must be retained as evidence of the date of purchase and to establish warranty eligibility.

### Where are Products Sent for Warranty Service?

Gletronics, Inc., 645 Heathrow Drive, Lincolnshire, IL 60069

### How Can I Obtain More Information?

By calling 800-991-0466



# Additional Products to Help Protect Your Basement

## Maintenance Free Battery B12-100



### Compatible with:

- All current Pro Series backup and combo systems

### Pro Series Maintenance Free/AGM Standby Batteries are designed to:

- Provide dependable service without having to add battery fluid or distilled water
- Run the pump longer for more hours per charge
- Work with all backup and combination systems
- Last longer in standby operation



## Clenit™ Pump and Pit Cleaner CL7



### FEATURES AND BENEFITS:

- Removes iron ochre, the red slime buildup, from your sump system and pit
- Helps to keep your pump and pit healthy
- Great solution for periodic pit maintenance

### Easy to Use:

- Pour Clenit™ into your sump system
- Allow the proprietary powder to attack the iron ochre
- Fill your pit with water so that your pump evacuates the pit and expels the iron ochre

## Pro Series CONNECT™ WiFi2 Module PS-WIFI2



### FEATURES AND BENEFITS:

- Sends emails, texts or in-app notifications and status alerts to your phone, tablet or computer
- NO MONTHLY FEE
- Connect using home Wi-Fi
- Simple setup
- Pro Series CONNECT free mobile app allows you to see your backup pump status and receive updates

## Sewage Pump E7055



### FEATURES AND BENEFITS:

- ½ HP
- 5,340 GPH (89 GPM) at 10' lift
- Cast-iron construction
- Energy-efficient permanent split capacitor (PSC) motor
- Handles 2" solids through a 2" discharge
- Continuous-duty rated
- Dual carbon/ceramic seals plus (1) Buna-N-Seal
- Upper and lower sealed ball bearings
- Stainless-steel fasteners
- Cast-iron impeller
- 3-year warranty

# Water Alarms & Accessories

## Water Alarm PWA2



### FEATURES AND BENEFITS:

- Minimizes the risk of water damage
- Detect leaks before they become bigger problems by placing a Pro Series water alarm wherever water damage is a risk
- 110 db alarm sounds when as little as 1/32" of water reaches the sensor
- Helps keep MOLD away by alerting to its major cause—water
- Includes 6' of sensor wire for remote monitoring
- Wire can be extended to over hundreds of feet
- Standalone water alarm has built-in accessory jack for optional add-on accessories

## 360° Sensor PS-WS360



### FEATURES AND BENEFITS:

- Patented 360° sensing technology detects water when placed on any side, top or bottom
- Use with the Pro Series Water Alarm (PWA2)
- When water reaches the 360° water sensor, an audible alarm will sound on the connected device
- 360° water sensor is only 1/2" thick, making it perfect for monitoring in tight spaces such as on the floor, or anywhere water damage is a risk
- Can monitor multiple locations by connecting additional sensors with no extra hardware
- Includes 20' cord

## 360° Water Alarm PWA-360



### FEATURES AND BENEFITS:

- Patented design allows the device to sense water on any side
- Detects as little as 1/32" of water
- Small size (2 3/8" x 1" x 3 1/4") fits in tight spaces
- Loud 110 dB alarm easy to hear anywhere in the house
- Waterproof to ensure the device works when it counts
- Save money by detecting leaks early, heading off costly water damage and mold
- Solid-state circuitry is both very sensitive and reliable
- Only extracts power from the battery when the alarm is sounding, extending battery life

## Pro Series CONNECT™ High Water Accessory PS-WS



### FEATURES AND BENEFITS:

- Will activate a warning light, an audible alarm, send a signal to the remote terminal, and send information through the USB port when water reaches the sensor
- Use with the Pro Series Deluxe Float Controller (DFC2, VSC2 and TSC2) and Water Alarm (PWA2)
- Attaches to the discharge pipe with included mounting hardware
- 10' cord with plug

## 20-Ft. Extension EXT-PWA20



### FEATURES AND BENEFITS:

- For use with 360° Sensor (PS-WS360) and Water Sensor (PS-WS)
- 20' cord
- Rubber gasket and sleeve for waterproofing the connection between the extension and sensor

