



# Exceeding Expectations

- Energy-Efficient AC Pumps
- Battery Backup Sump Pumps
- Combination Pumps
- Sewage Pumps
- Innovative Switch Technologies
- Water Alarms
- Batteries



StopFlooding.com

## Industrial Grade for the Residential Market



# Pro Series™ Pumps

## Table of Contents

<b>PRO SERIES PUMPS</b>		<b>C8 SERIES CHEMICAL PUMP</b>	<b>13</b>
Why Pro Series Pumps	2	<b>SWITCHES &amp; CONTROLLERS</b>	<b>14-16</b>
Unmatched Support—The Tools for Success	3	Switches	14
Strong and Dependable Pumps	3	Controllers	15
<b>RELIABILITY AND INNOVATION</b>	<b>4</b>	Alternators	16
<b>GOOD, BETTER, BEST PRODUCT OPTIONS</b>	<b>5</b>	<b>CONNECT WIFI MODULE</b>	<b>16</b>
<b>MIX AND MATCH ORDERING</b>	<b>6</b>	<b>BENEFITS OF A BACKUP OR COMBO SYSTEM</b>	<b>17</b>
<b>SUMP PUMPS</b>	<b>7-10</b>	<b>BACKUP PUMPS</b>	<b>18-19</b>
Sump Pump Components and Construction	7	<b>COMBINATION PUMPS</b>	<b>20-21</b>
S1 and ST Sump Pumps	8	<b>ACCESSORIES</b>	<b>22-25</b>
S2 Series Sump/Effluent Pump	8	Standby Battery, Parallel Jumper Cables	22
S3 Series Sump Pump	8	Clenit™ Pit Cleaner	22
SR33-VS Sump Pump	9	Sump Foot, Cord Management Box, Water Sensor	23
The Cast Iron Sump Pump	9	Water Alarms	24
Packaged Crawlspace Kit	10	Check Valves	25
<b>SEWAGE PUMPS</b>	<b>11-13</b>	<b>CHOOSING THE RIGHT PUMP</b>	<b>26-27</b>
Preassembled Sewage Pits	11	<b>COMPANY PROFILE AND CONTACT INFO</b>	<b>28</b>
E Series	12-13		

## Why Pro Series Pumps

**Our focus has always been creating and improving our products to make reliable pumps and other accessories that will benefit our customers.**

That begins by using premium components and designing pumps for maximum pumping capacity, durability, and greater energy efficiency, which is why we lead the industry in green technology. Our patented switches and controllers with state-of-the-art monitoring systems are the result of our innovative engineering.

Pro Series Pumps also excels in helping our customers maximize their business with the unique Good, Better, Best system, which allows you to offer a range of products to best fit your customers' needs while pumping up your profits. Using our Mix and Match ordering system, you can stock your inventory while saving on your product investment.

In addition to offering quality products and better ordering options, we back it all up with unmatched support. We provide extended warranties that benefit our professionals, free customized leave-behind sheets, training sessions and lifetime technical support. You also can be listed as a Pro Series Preferred Installer on our website.

**We present you with the means to success!**



# Pro Series™ Pumps

## Unmatched Support—The Tools for Success

### THE MEANS TO SUCCESS

Pro Series backup and AC sump pumps are more than just the leading pumps in the industry—we support your customers and your sales efforts. Let us share our secrets so we can help you sell more products.

#### Warranties

- Confidence in our products allows us to offer better warranties on our most popular pumps when installed by a contractor
- Start from the date of installation

#### FREE Leave-Behind Sheets

- Available for backup, AC pumps and combination pumps to leave with your customers
- Customized with your logo, phone number and website

#### FREE Training Sessions

- For you and your staff to help sell our products effectively
- Sessions available at your facility or ours

#### FREE Technical Support

- FREE lifetime technical support for you and your customers
- If you prefer, have your customers call our U.S.-based technical support team—trained to troubleshoot problems over the phone

#### FREE Listing on Our Distributors' Pages

- Allows contractors to find the closest stocking wholesalers in their area with the distributor's information and website link

#### FREE Listing as Pro Series Preferred Installer

- Sign up to be listed on our website as a Preferred Installer
- To be eligible, you must purchase at least four of our systems from your local wholesaler

**Your Logo Here**

Select the Sump Pump System that's best for you!

**GOOD**

**CIS-33V — Sump/Effluent Pump with Built-in Vertical Switch**

- Pumps 3,200 GPH @ 10'
- Cast iron construction
- 1/3 HP energy efficient PSC motor
- Reliable built-in vertical switch
- Cast iron 6 blade vortex impeller
- Pumps solids up to 1/2"
- Removable strainer
- 3 year warranty

\$ \_\_\_\_\_

**BETTER**

**S3033-DFC2 — Sump Pump and Dual Float with Deluxe Controller**

**Pump:**

- Pumps 3,000 GPH (46 GPM) at 10 ft. lift
- Cast iron / stainless steel construction
- 1/3 HP energy efficient PSC motor
- 5 year warranty

**Deluxe Controller:**

- Two float switches for added protection
- Sounds an alarm and alerts when power has failed, a pump or float problem is detected or the battery is low
- USB Data Port and Remote Terminal connect to external devices such as the Pro Series Pumps CONNECT module, or other devices for remote notification
- Exercises the pump weekly to extend pump life

\$ \_\_\_\_\_

**BEST**

**PS-C33 — Combination System Battery Backup and Sump Pump**

**Primary Pump:**

- Pumps 3,000 GPH (50 GPM) at 10 ft. lift
- Cast iron / stainless steel construction
- 1/3 HP energy efficient PSC motor

**Backup Pump:**

- 2,400 GPH (40 GPM) at 10 ft. lift
- Unique monitoring controller detects irregularities, sounds an alarm, pinpoints problems and solutions on control panel
- Runs pump weekly to test for proper operation & alerts if there is a pump problem
- Caged dual float switch for added reliability
- Receive notifications about your Pro Series 2400 backup sump pump system while away from home using a Pro Series CONNECT module
- Designed for use with maintenance or maintenance free batteries
- 4-Year Warranty

## Strong and Dependable Pumps

### DESIGNED FOR HIGHER PUMPING CAPACITY AND INCREASED ENERGY EFFICIENCY, RESULTING IN PROVEN RELIABILITY

#### Premium Components

- Industrial-grade products, built for the residential market
- Built to run continuously, 24 hours a day, 7 days a week, 365 days a year (S1/ST Series, S3 Series, E7 Series and C8 Series)

#### The entire Pro Series AC pump line incorporates:

- PSC motors and thermal protection
- Upper and lower sealed ball bearings
- Durable pump housings
- Harmonically balanced, quiet operation
- Double or triple seals to ensure the pump lasts longer

### BETTER WARRANTIES FOR EXTENDED PEACE OF MIND

These upgrades result in powerful pumps that offer superior energy efficiency, durability and longevity. Using industrial-grade components means we can offer warranties ranging from 1 year, 18 months, 3 years, 4 years, and up to 5 years.



# Reliability and Innovation

## A Better Warranty

System	Contractor Installation	
	Model	Warranty
Battery Backup Pumps	All backup systems	<b>3 years</b>
Combination Pumps	PS-C33, PS-C50 PS-C11, PS-C22	<b>4 years*</b> <b>3 years</b>
Energy-Efficient Sump Pumps	S3 Series	<b>5 years*</b>
	S2 Series	<b>4 years*</b>
	ST, S1 CIS	<b>3 years*</b> <b>3 years</b>
	SR33-VS	<b>18 months</b>
Sewage Pumps	All sewage pumps	<b>3 years</b>
Chemical Pumps	All chemical pumps	<b>1 year</b>
Pump Alternator	All DVSA models	<b>3 years</b>

**We stand behind our products and those who install them by offering warranties that can be relied on.**

Premium components make our pumps dependable and durable, which allows us to offer better warranties that begin from the date of installation.

In a continued effort to support professional installers, we have increased the warranty on our most popular products when purchased and installed by a professional. Extending the warranties not only shows trust in our products but also trust in our professionals and gives your customers peace of mind.

The warranty on all Pro Series switches matches that of the Pro Series pumps when installed new together. Otherwise, a one-year warranty applies to the switch when installed separately or on another product.

The warranty on Pro Series batteries is one year from the date of installation, when used with a Pro Series battery backup or combination sump pump system.

\*Applicable when purchased and installed by a contractor.

## On the Forefront of Technology

### Patented Dual Float Switch

- Two redundant floats mounted within a protective cage to ensure reliable operation

### State-of-the-Art Monitoring

- 24-hour-a-day monitoring of system and power conditions and gives visual and audible alerts when problems are detected, giving customers peace of mind that their system is ready to go

### Connected Pumps with Remote Notification

- All CONNECT™ models within the Pro Series line have a USB data port and remote terminal which allow the controller to be connected to the Pro Series WiFi Module or other external device that can notify a homeowner of a problem or needed maintenance
- See the status of the pump and receive emails, text, or push notifications to phone, tablet or computer



# Selection and Quality Guarantee

## Good, Better, Best Product Options

The Pro Series line includes a **Good, Better, Best** option in every major product category. We are the only pump company offering this kind of variety in AC pumps, controllers, backup pumps and combination systems.

- Each product has unique features
- Allows you to stock a better selection
- Solutions to meet your customers' needs
- Offer products that best fit your customers' budget
- Gives you an opportunity to maximize your business
- Offering a range of products means higher profitability
- Easy to offer a better product to your customer
- Don't forget to suggest a backup or combination system

**GOOD**

**BETTER**

**BEST**

### STEP 1: PICK A PUMP



#### S1/ST Series

- Cast iron
- 2,770 GPH<sup>†</sup> (S1033)
- 3-year warranty\*



#### S2 Series

- Cast iron
- 3,200 GPH<sup>†</sup> (S2033)
- 4-year warranty\*



#### S3 Series

- Cast iron/  
stainless steel
- 3,000 GPH<sup>†</sup> (S3033)
- 5-year warranty\*

### STEP 2: PICK A SWITCH



#### Tether Switch

- Clear water or sewage
- Adjustable



#### Vertical Switch

- Clear water or sewage
- Compact
- Adjustable



#### Dual Float Switch

- Redundant protection
- Compact
- Adjustable

### STEP 3: PICK A CONTROLLER



#### C1 (Standard)

- Works with dual float switch



#### C1.5 (Enhanced)

- Exercises pump weekly
- Adjustable runtime



#### C2 (Deluxe)

- Lights and alarms
- Connects to Wifi Module
- Adjustable runtime

## Don't Forget to Add a Backup System



#### PHCC-1000

- 1,000 GPH<sup>†</sup>
- .4-Amp charger



#### PHCC-1850

- 1,850 GPH<sup>†</sup>
- 1.6-Amp charger
- Connects to WiFi Module



#### PHCC-2400

- 2,400 GPH<sup>†</sup>
- 13-Amp charger
- Connects to WiFi Module

\*Warranty applies when purchased and installed by a contractor. †Capacity is at a 10-foot lift.

NOTE: This is just a sample of our Good, Better, Best product selection; ask your sales representative for more info on additional product lines and the Good, Better, Best options available with those products.

(800) 991-0466





# Mix and Match Ordering

## Ordering Sump and Sewage Pumps

### We give you the flexibility to order any pump with any switch!

To provide you with the best options for stocking your inventory, you can order using our Mix and Match method or instead select a prepackaged pump with a switch included. The Mix and Match ordering system provides you with the best options for stocking your inventory while also saving on your product investment.

#### OPTION 1: MIX AND MATCH – ORDER A PUMP AND A SWITCH AS SEPARATE ITEMS

- Allows you to stock pumps and switches as separate items, then combine and complete the system to meet your customers' needs
- Enables you to stock less inventory, lowering your product investment
- Provides you with the product and tools to upgrade the sale

##### First, order any pump with no switch (NS)

- |  |                                   |
|--|-----------------------------------|
| <input type="checkbox"/> S1033-NS            | <input type="checkbox"/> S3050-NS |
| <input type="checkbox"/> ST1050-NS           | <input type="checkbox"/> S3100-NS |
| <input type="checkbox"/> S2033-NS            | <input type="checkbox"/> E7040-NS |
| <input type="checkbox"/> S2050-NS            | <input type="checkbox"/> E7055-NS |
| <input checked="" type="checkbox"/> S3033-NS | <input type="checkbox"/> E7105-NS |

##### Then, order any switch

- |                                 |                                 |  |
|---------------------------------|---------------------------------|--|
| <input type="checkbox"/> TS     | <input type="checkbox"/> VS     | <input type="checkbox"/> DFC1            |
| <input type="checkbox"/> TSC1.5 | <input type="checkbox"/> VSC1.5 | <input type="checkbox"/> DFC1.5          |
| <input type="checkbox"/> TSC2   | <input type="checkbox"/> VSC2   | <input checked="" type="checkbox"/> DFC2 |
| <input type="checkbox"/> TSC3   | <input type="checkbox"/> VSC3   | <input type="checkbox"/> DFC3            |

S3033 pump with no switch (NS) in the box



- S3033-NS 1/3 HP - Pump Only  
1-1/2" Discharge - 10' Power Cord
  - S3050-NS 1/2 HP - Pump Only  
2" Discharge - 20' Power Cord
- Float switches and controllers are available!

These items will be packaged separately



DFC2 in the box

#### OPTION 2: ORDER AS A PREPACKAGED SYSTEM – INCLUDES PUMP AND SWITCH

- Order any pump with switch already packaged in a single carton, ready for delivery

Order as a complete system with switch already packaged in the box

To order an S3033 pump with a DFC2, the part number is **S3033-DFC2**



##### S3033-DFC2 – 1/3 HP Pump with Deluxe Controller and Dual Float Switch

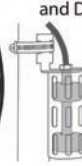

- Activates pump weekly to exercise and extend pump life
- Monitors pump and power conditions and sounds an alarm when problems are detected
- Designed for sump application



# Quality Parts and Construction

## Premium Components = Quality Pumps

All Pro Series sump pumps use less electricity than competing pumps while still providing better performance. They feature a high-efficiency Permanent Split Capacitor (PSC) motor, which uses fewer Amps. Our pumps offer upper and lower sealed ball bearings, which increase efficiency, durability and allow for quiet operation. These upgrades result in a powerful motor that is efficient, durable and has a long life.

### Premium Components Means GREEN SAVINGS

All Pro Series AC pumps use substantially fewer Amps than shaded-pole pumps from other manufacturers, which means our pumps are considerably less expensive for a homeowner to operate. Superior energy efficiency translates to lower energy bills for the homeowner. See [www.StopFlooding.com](http://www.StopFlooding.com) for more details.

## AC Pump Components and Construction

1.	<b>Permanent Split Capacitor (PSC) Motor:</b>	Increases energy efficiency
2.	<b>Housing:</b>	Cast-iron/stainless-steel housing (S3 Series, E7040, E7105) Cast-iron housing (S1 Series, CIS, S2 Series, E7055) Cast-iron/cast-aluminum housing (ST Series) Cast-aluminum/nylon housing (SR Series) Stainless-steel housing (C8 Series)
3.	<b>Strainer:</b>	Chrome-plated steel strainer (S3100) Electroplated steel strainer (ST Series) Noncorrosive polypropylene strainer (SR Series, S1 Series, S3033, S3050, ) Removable polycarbonate strainer (CIS, S2 Series)
4.	<b>Shaft:</b>	Stainless steel (S3 Series, C8 Series)
5.	<b>Upper and Lower Sealed Ball Bearings:</b>	Provide quiet operation that homeowners appreciate
6.	<b>Water Cooled (no cooling oil):</b>	S1 Series, ST Series, S3 Series, E7 Series, C8 Series
7.	<b>Thermally Protected:</b>	All AC pump models
8.	<b>Seals:</b>	Two carbon ceramic shaft seals plus one Buna-N Seal (S1 Series, ST Series, S3 Series, E7 Series) Carbon ceramic shaft seal plus one Buna-N Seal (SR Series, CIS, S2 Series) Silicon carbide Viton seals (C8 Series)
9.	<b>Discharge Outlet:</b>	1.5" outlet (SR33-VS, S1033, CIS, S2 Series, S3033) 2" outlet (ST1050, S3050, S3100, E7 Series, C8050, C8100)
10.	<b>Impeller:</b>	Dynamically balanced cast iron (S3100) Polycarbonate (S3033, S3050) Cast-iron vortex (CIS, S2 Series, E7 Series) Engineered polymer (SR Series, S1 Series, ST Series) Stainless steel (C8 Series)

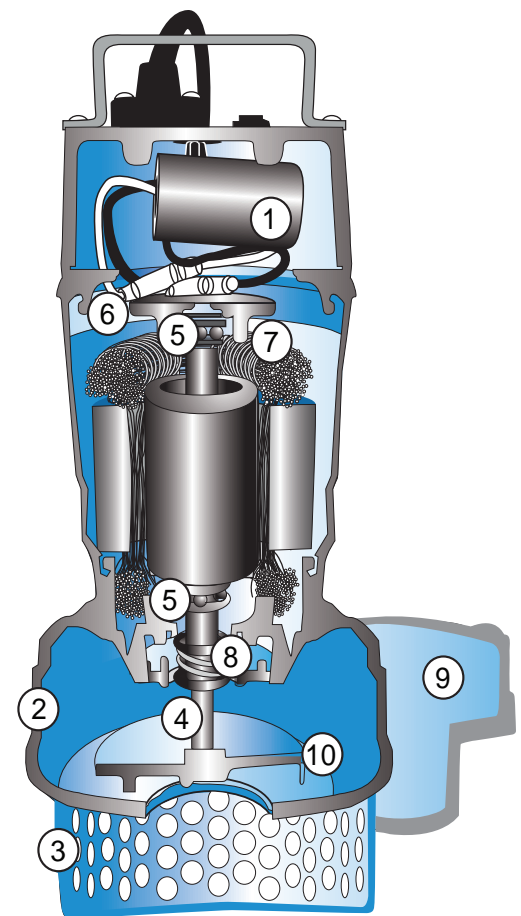



# Sump Pumps



## S1 and ST Series Sump Pump



### Features

- Can be paired with your choice of tether, vertical or dual float switch and controller
- Cast-iron (S1033), Cast-iron/cast-aluminum (ST1050) construction
- Continuous-duty rated
- Energy-efficient Permanent Split Capacitor (PSC) motor
- Upper and lower ball bearings
- Two carbon ceramic shaft seals plus one Buna-N Seal
- Water-cooled motor (no cooling oil)
- Stainless-steel fasteners
- 10-foot pump cord (20-foot option)

	S1033-NS	ST1050-NS
Motor HP	1/3 HP	1/2 HP
GPM @ 10 Ft	46	72
GPH @ 10 Ft	2,770	4,320
Max Head	29 ft/8.8 m	32 ft/9.8 m
Discharge	1.5 in/3.8 cm	2 in/5.1 cm
Amps @ 10 Ft	3.8	4.8
Weight	24.5 lb/11.1 kg	28 lb/12.7 kg
Width	7.5 in/19.1 cm	10 in/25.4 cm
Depth	5 in/12.7 cm	6.5 in/16.5 cm
Height	13.8 in/34.9 cm	16.3 in/41.3 cm

\* 3-year warranty is available when purchased and installed by a contractor; otherwise the original 18-month warranty is applicable.

## S2 Series Sump/Effluent Pump



### Features

- Can be paired with your choice of tether, vertical or dual float switch and controller
- Cast-iron construction
- Energy-efficient Permanent Split Capacitor (PSC) motor
- Cast-iron vortex impeller
- Upper and lower ball bearings
- Carbon ceramic plus Buna N shaft seals
- Stainless-steel fasteners
- Pumps solids up to .5 inch
- Removable strainer
- 10-foot pump cord (20-foot option)

	S2033-NS	S2050-NS
Motor HP	1/3 HP	1/2 HP
GPM @ 10 Ft	53	64
GPH @ 10 Ft	3,200	3,840
Max Head	23 ft/7 m	26 ft/8 m
Discharge	1.5 in/3.8 cm	1.5 in/3.8 cm
Amps @ 10 Ft	5	5.5
Weight	21.1 lb /9.5 kg	22 lb/9.9 kg
Width	8.5 in/21.6 cm	8.5 in/21.6 cm
Depth	6.5 in/16.5 cm	6.5 in/16.5 cm
Height	12 in/30.4 cm	12 in/30.4 cm

\* 4-year warranty is available when purchased and installed by a contractor; otherwise the original 3-year warranty is applicable.

## S3 Series Sump Pump



### Features

- Can be paired with your choice of tether, vertical or dual float switch and controller
- Cast-iron/stainless-steel construction
- Continuous-duty rated
- Energy-efficient Permanent Split Capacitor (PSC) motor
- Upper and lower ball bearings
- Two carbon ceramic shaft seals plus one Buna-N Seal
- Water-cooled motor (no cooling oil)
- Stainless-steel fasteners
- 10-foot pump cord (S3033 – 20-foot option available)
- 20-foot pump cord (S3050, S3100)

	S3033-NS	S3050-NS	S3100-NS
Motor HP	1/3 HP	1/2 HP	1 HP
GPM @ 10 Ft	50	65	92
GPH @ 10 Ft	3,000	3,900	5,520
Max Head	30 ft/9.1 m	33 ft/10.0 m	52 ft /15.9 m
Discharge	1.5 in/3.8 cm	2 in/5.1 cm	2 in/5.1 cm
Amps @ 10 Ft	4.0	4.3	11.5
Weight	20 lb/9.1 kg	24 lb/10.9 kg	46 lb/20.9 kg
Width	7.9 in/20.1 cm	8.5 in/21.6 cm	11.0 in/27.9 cm
Depth	5.3 in/13.5 cm	6.3 in/16.0 cm	7.7 in/19.5 cm
Height	13.0 in/33.0 cm	13.4 in/34.0 cm	18 in/45.7 cm

\* 5-year warranty is available when purchased and installed by a contractor; otherwise the original 3-year warranty is applicable.



# Sump Pumps



**18 MONTH WARRANTY**

## SR33-VS Sump Pump

### Features

- Built-in vertical switch
- Cast-aluminum body/durable nylon cover with polypropylene volute
- Energy-efficient Permanent Split Capacitor (PSC) motor
- Upper and lower sealed ball bearings
- Carbon ceramic plus Buna N shaft seals
- Stainless-steel fasteners
- 10-foot pump cord
- Will fit in 10-inch diameter sump pit

	SR33-VS
Motor HP	1/3 HP
GPM @ 10 Ft	47
GPH @ 10 Ft	2,820
Max Head	24.6 ft/7.5 m
Discharge	1.5 in/3.8 cm
Amps @ 10 Ft	3.3
Weight	12.2 lb/5.5 kg
Width	8 in/20.3 cm
Depth	6 in/15.2 cm
Height	12.5 in/31.8 cm



**3 YEAR WARRANTY**

## The Cast Iron Sump Pump

	CIS-33V	CIS-50V
Motor HP	1/3 HP	1/2 HP
GPM @ 10 Ft	53.3	64
GPH @ 10 Ft	3,200	3,840
Max Head	23 ft/7 m	26 ft/8 m
Discharge	1.5 in/3.8 cm	1.5 in/3.8 cm
Amps @ 10 Ft	5	5.5
Weight	21 lb/9.5 kg	22 lb/9.9 kg
Width	8.5 in/21.6 cm	8.5 in/21.6 cm
Depth	6.5 in/16.5 cm	6.5 in/16.5 cm
Height	12 in/30.4 cm	12 in/30.4 cm

### Features

- Built-in vertical switch
- Cast-iron sump/effluent pump
- Energy-efficient Permanent Split Capacitor (PSC) motor
- Cast-iron vortex impeller
- Upper and lower ball bearings
- Carbon ceramic plus Buna N shaft seals
- Pump activates at 7.125 inches and turns off at 2.25 inches



## Pump Performance

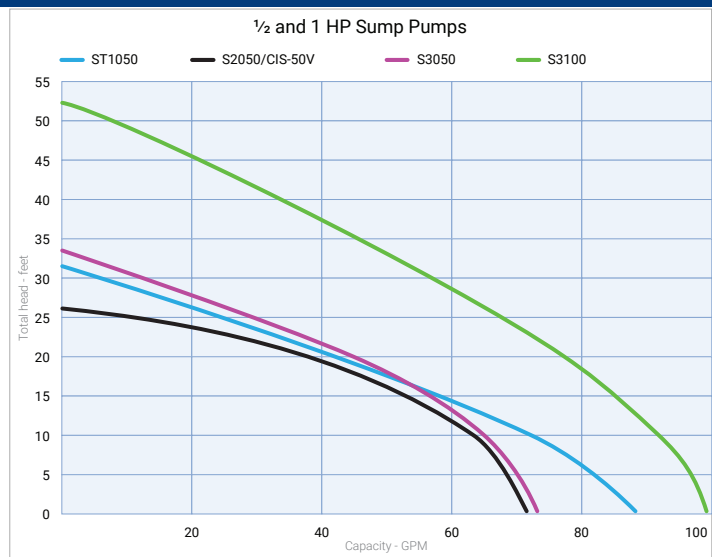
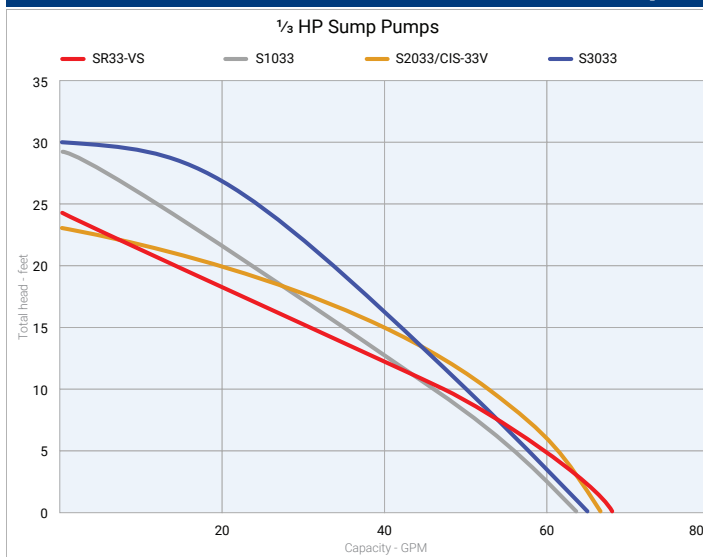

(800) 991-0466





# Packaged Crawlspace Kit

## Crawlspace Sump Pump Kit



### Packaged Crawlspace Kit

Pro Series packaged crawlspace kit comes with all the items in the box, ready to be assembled and installed in your sump pit.

### Kit Includes

- Cast-iron CIS-33V pump
- Compact sump pit
- PWA2 water alarm & extension
- PS-WS water sensor
- SF1A sump foot
- Mounting hardware (for foot, sensor & lid)

### Pit Features

- 12.5 X 15-inch perforated pit
- 2-hole cover: 1.5" discharge pipe and cord seal
- Long-lasting structural foam
- Pit capacity: 7.3 U.S. gallons

### Pump Features

- 1/3 HP energy-efficient Permanent Split Capacitor (PSC) motor
- Built-in vertical float switch
- Cast-iron vortex impeller
- Upper and lower ball bearings
- Carbon ceramic plus Buna N shaft seals
- Thermally protected
- Stainless-steel fasteners
- Pumps solids up to 1/2 inch
- Removable strainer
- 10-foot power cord
- 3-year limited warranty

Pump Model	CIS-33V
Motor HP	1/3 HP
GPM @ 10 Ft	53.3
GPH @ 10 Ft	3,200
Discharge	1.5 in/3.8 cm
Amps @ 10 Ft	5
Weight	21 lb/9.5 kg
Width	8.5 in/21.6 cm
Depth	6.5 in/16.5 cm
Height	12 in/30.4 cm
Activation Level	8.25 in/21 cm
Deactivation Level	3.5 in/9 cm

## Pump Performance

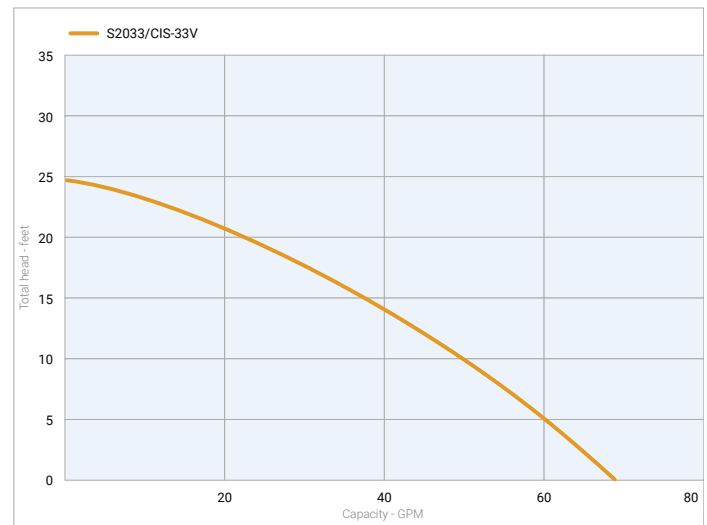

### Water Alarm (PWA2)

- 110 db alarm will sound when water lifts the water sensor or reaches the touch pads
- Kit includes water alarm (PWA2), water sensor (PS-WS), hose clamp, and 50-foot extension (EXT-PWA-50B)



### Sump Foot (SF1A)

- Keeps pump out of pit debris
- Predrilled holes for easy installation
- Made of high-impact polypropylene



# Preassembled Sewage Pits

## Preassembled Sewage Pit (EP Series)

### Preassembled Sewage Pit

The preassembled sewage pits come prefabricated for easy installation. Select the pump size needed, the style of float, and pick the controller with the feature level desired.

- Energy-efficient sewage pump in  $\frac{1}{10}$ ,  $\frac{1}{2}$  and 1 HP
- Pump rests in a formed mold, which prevents torquing
- 3 float controller options

### Pit includes

- Sewage pump and switch
- 18- x 30-inch sewage pit with rubber inlet
- Lid with flanges, inspection panel and cord seal
- All gaskets and stainless-steel hardware
- 2-inch discharge piping from the pump to the lid
- PS-WS included with VSC2, which meets code where an alarm is required

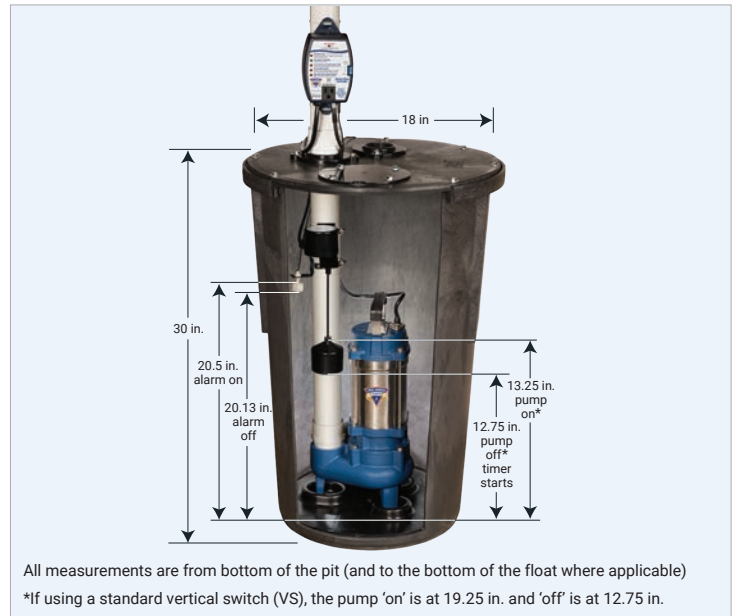

## Choose Your Pump Size



$\frac{1}{10}$  HP – EP7040



$\frac{1}{2}$  HP – EP7055



1 HP – EP7105

## CHOOSE THE SWITCH/CONTROLLER FEATURES NEEDED



**VS**  
vertical switch  
w/piggyback  
plug

- Standard (120 VAC) version  
EP7040-VS, EP7055-VS, EP7105-VS



**VSC1.5**  
vertical switch  
w/enhanced  
controller

- Activates pump weekly to exercise and extend pump life
- LED confirms controller has power
- Pump runtime is adjustable
- Sealed gold contacts for reliable operation  
EP7040-VSC1.5, EP7055-VSC1.5, EP7105-VSC1.5



**VSC2**  
vertical switch  
w/deluxe  
controller

- Monitors pump and power conditions, sounds an alarm when problems are detected
- Visual/audible notification and recommended maintenance remedy
- Activates pump weekly to exercise and extend pump life
- Pump runtime is adjustable
- Connects to the Pro Series WiFi Module, home security systems or other devices
- Optional High Water Accessory (PS-WS) will sound an alarm when high water is present
- Sealed gold contacts for reliable operation  
EP7040-VSC2, EP7055-VSC2, EP7105-VSC2



# Sewage Pumps



## E Series Features

- Cast-iron/stainless-steel construction (E7040, EBIS40V, E7105), cast-iron construction (E7055)
- Energy-efficient Permanent Split Capacitor (PSC) motor
- Handle 2-inch solids with 2-inch discharge
- Continuous-duty rated
- Water-cooled motor (no cooling oil)
- Electroplated steel shaft
- Stainless-steel fasteners
- Dual carbon/ceramic shaft seals plus Buna N seal
- Upper and lower sealed ball bearings
- 10-foot power cord; (20-foot option available – pump model-20)
- **Switch:**
  - E7040, E7055, E7105 come with no switch, giving you the versatility to pair the pump with a tether or vertical switch (separate purchase)
  - EBIS40V includes a built-in vertical switch



## Specifications

	E7040-NS	EBIS40V	E7055-NS	E7105-NS
Motor HP	4/10 HP	4/10 HP	1/2 HP	1 HP
Switch	NS - No Switch*	Built-in Vertical	NS - No Switch*	NS - No Switch*
GPM @ 10 Ft	74	74	89	100
GPH @ 10 Ft	4,440	4,440	5,340	6,000
Max Head	22 ft/6.7 m	22 ft/6.7 m	23 ft/7.0 m	32 ft/9.7 m
Max Diameter Solids	2 in/5.1 cm	2 in/5.1 cm	2 in/5.1 cm	2 in/5.1 cm
Discharge	2 in NPT/5.1 cm	2 in NPT/5.1 cm	2 in NPT/5.1 cm	2 in NPT/5.1 cm
Amps @ 10 Ft	6.3	6.3	7.0	10.5
Weight	36 lb/16.3 kg	36 lb/16.3 kg	37 lb/16.8 kg	40 lb/18 kg
Width	9 in/22.9 cm	9 in/22.9 cm	9 in/22.9 cm	9 in/22.9 cm
Depth	5.875 in/15 cm	5.875 in/15 cm	5.875 in/15 cm	5.875 in/15 cm
Height	19 in/48.3 cm	19 in/48.3 cm	16.5 in/41.9 cm	20 in/50.8 cm

\* NS designates a model that comes without a switch. Switch and controller options are on pages 14-15.



## Sewage Pump Performance

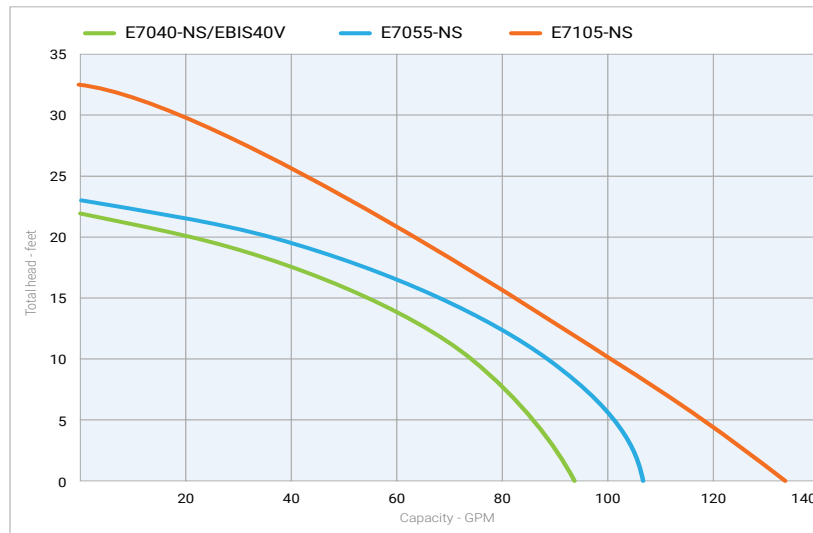

## C8 Series Chemical Pump

### Features

- All 304 stainless-steel construction
- Intended for pumping nonflammable fluids compatible with pump component materials
- Energy-efficient Permanent Split Capacitor (PSC) motor
- Upper and lower sealed ball bearings
- Dual carbon/ceramic/Viton seals
- Continuous-duty rated
- Liquid cooled

C8050-NS



C8100-NS



### Specifications

	C8050-NS	C8100-NS
Motor HP	½ HP	1 HP
GPM @ 10 Ft	64	82
GPH @ 10 Ft	3,840	4,920
Max Head	36 ft/11 m	49 ft/14.9 m
Discharge	2 in/5.1 cm	2 in/5.1 cm
Amps @ 10 Ft	4.7	11.3
Weight	23 lb/10.4 kg	46 lb/20.9 kg
Width	9.1 in/23.1 cm	10.4 in/26.4 cm
Depth	6.3 in/16 cm	7.5 in/19.1 cm
Height	16.3 in/41.4 cm	18.1 in/46 cm

### Chemical Pump Performance

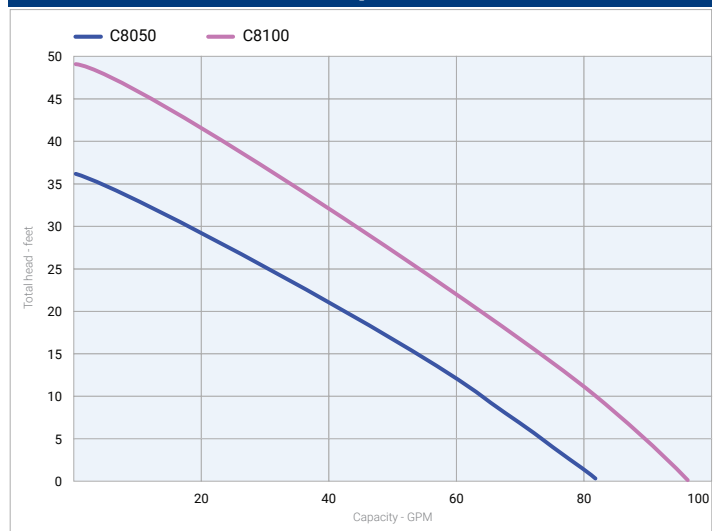



# Switches and Controllers

## TS—Tether Switch



### Features

- Clear water and sewage applications
- Two versions available:
  - Standard, piggyback switch (120 VAC) version—no controller (TS)—10-foot cord
  - Low Current switch, included with Enhanced, Deluxe or High-Cycle Controllers (TSC1.5, TSC2, TSC3)—10-foot cord
- Mounts to discharge pipe with included stainless-steel hose clamp
- Adjustable activation level
- Optional 20-foot cord available (Model # “-20”)



## VS—Vertical Switch



### Features

- Clear water and sewage applications
- Two versions available:
  - Standard, piggyback switch (120 VAC) version—no controller (VS)—10-foot cord
  - Low Current switch, included with Enhanced, Deluxe or High-Cycle Controllers (VSC1.5, VSC2, VSC3)—10-foot cord
- Sealed gold contacts for reliable, high-cycle operation
- Mounts to discharge pipe with included stainless-steel hose clamp
- Adjustable activation level
- Optional 20-foot cord available (Model # “-20”)



## DF—Dual Float Switch



### Features

- Two micro-reed-activated floats for added redundancy and protection
- Included with Standard, Enhanced, Deluxe or High-Cycle Controllers (DFC1, DFC1.5, DFC2, DFC3)—10-foot cord
- Detachable from controller during installation for feeding wire through pit cover (DFC1.5, DFC2, DFC3)
- Protective cage prevents debris from interfering with floats
- Solid top keeps out sand and dirt while vented, curved bottom prevents debris buildup
- Mounts to discharge pipe with included stainless-steel hose clamp
- Easy to install, adjustable activation level
- Optional 20-foot float cord available (Model # “-20”)



# Switches and Controllers

## Controller Features

### Standard Controller and Dual Float Switch (DFC1)

- Two micro-reed-activated floats for added reliability
- Protective cage prevents debris from interfering with floats
- Switch is mounted independently, allowing user to adjust the height of pump activation

### Enhanced Controller

- Available with a Tether Switch (TSC1.5), Vertical Switch (VSC1.5), or Dual Float (DFC1.5)
- Activates pump weekly to exercise and extend pump life
- Pump runtime is adjustable

### Deluxe and Ultimate Controller

- Available with a Tether Switch (TSC2), Vertical Switch (VSC2), or Dual Float (DFC2)
- Monitors pump and power conditions and sounds an alarm when problems are detected
- Visual/audible notification and recommended maintenance remedy
- Activates pump weekly to exercise and extend pump life
- Pump runtime is adjustable
- USB data port and remote terminal connect to the Pro Series CONNECT WiFi Module, or other devices for remote notification
- 3.5 mm accessory jack allows connection to High Water Accessory or 360° Water Sensor (Deluxe Controller only)

### Standard



### Enhanced



### Deluxe



### High-Cycle



## Controller Comparison

	Standard	Enhanced	Deluxe	High-Cycle
	DFC1	TSC1.5, VSC1.5, DFC1.5	TSC2, VSC2, DFC2	TSC3, VSC3, DFC3
Available with Dual Float Switch	•	•	•	•
Available with Vertical Switch		•	•	•
Available with Tether Switch		•	•	•
Sounds an alarm and alerts when:				
AC power has failed			•	•
Pump or float problem is detected			•	•
9V battery is low or slide switch is off			•	•
Remote Notification Connections:				
USB data port (remotely notifies of specific issues and needed maintenance using Pro Series WiFi Module)			•	•
Remote terminal (remotely notifies about general issues with your system using Pro Series WiFi Module, home security system, or other device)			•	•
Float switch can be unplugged from controller for easy installation		•	•	•
System operating light		•	•	•
Adjustable runtime from 5–45 seconds after the water falls		•	•	•
Activates pump weekly to exercise and extend pump life		•	•	•
3.5 mm accessory jack			•	
Utilizes solid-state circuitry for high cycling				•
Power-cord length	N/A	2 ft.	4 ft.	4 ft.
10-foot piggyback float-switch cord	•	•	•	•



# Switches and Controllers



## Pump Alternator Control and Alarm System

### Features

- Prolongs pump life by alternating two primary pumps
- If one pump fails, the other pump will take over and an alarm will sound
- Flashing light will indicate which pump is failing
- Remote terminal allows the unit to connect to the Pro Series WiFi Module, security system or other dry-contact-based device
- If one float switch fails, the other float switch will take over and an audible alarm will sound
- Detachable float-switch wires for easy installation
- Angled receptacles to accept standard or right-angled pump plugs
- High Water Alarm with accompanying LED indicator, audible alarm, and 9V battery backup



### Dual Activation Pump Alternator DVSA-DF/DVSA-VS

- Can run both pumps at the same time for extra capacity (total 15 Amps)
- Includes your choice of either:
  - 2 low-voltage vertical float switches (DVSA-VS)
  - Two caged dual float switches (DVSA-DF)
- Built-in circuit breakers for both pumps (15 Amps max)

### Single Activation Pump Alternator DVSA

- Runs one pump at a time
- Can handle up to 1 HP pumps (max 15 Amps per pump)



## Pro Series Pumps CONNECT™—Remote Notification

### Are your customers afraid to leave the house during a storm, not knowing if they will come back to a flooded basement?

The Pro Series Pumps CONNECT line of pumps has the ability to alert homeowners via text, email, or push notification to a problem in the pit or if maintenance is needed

- Connect using the Pro Series WiFi Module to the home Wi-Fi
- Connect to home security system or other dry-contact-based device using the remote port

### PRO SERIES WIFI MODULE

The Pro Series WiFi Module lets the CONNECT backup, combo or primary pump hook up to the local Wi-Fi, allowing the customer to see the status of the pump and receive alerts when needed

- Sends email, text, or push notifications to phone, tablet or computer
- FREE Apple and Android app available
- No monthly fee
- Simple setup



### Remote Notification Compatibility:



### PRIMARY PUMP SWITCH:

TSC2, VSC2, DFC2, TSC3, VSC3, DFC3, DVSA

### BACKUP SYSTEMS:

PHCC 1850, PHCC 2400

### COMBO SYSTEMS:

PS-C22, PS-C33, PS-C50





# Battery Backup Sump Pumps



## Why Your Customer Needs a Backup Sump Pump System

### If the power goes out, the main AC pump will not run and the basement will flood.

The Pro Series backup system will pump intermittently for days, providing a secondary pumping source. For increased runtime, the larger backup models can handle extra batteries.

### If the main pump fails due to a mechanical problem or if the pump is clogged with debris, the basement will flood.

The Pro Series system will provide a secondary pump and keep the basement dry.

### If the float switch on the main pump gets stuck or fails, the basement will flood.

The Pro Series backup system will activate, pump the water out, and sound an alarm that the main pump did not activate.

### If the discharge pipe in the main pump is clogged or frozen, or if the sewer is full, the basement will flood.

The Pro Series system will provide a secondary discharge line when plumbed directly outside. The water will have somewhere to go other than the basement.



## Why Pro Series Backup and Combination Systems

### Proven Reliability

- Decades preventing basements from flooding
- Features the most complete monitoring alarm system and high-capacity pumps
- Designed to be a major appliance with years of dependable service
- 100% factory tested

### Redundancy

- Dual float switches on all backup systems provide twice the protection
- Combination systems have four float switches to ensure the pumps run when needed
- Backup pumps can be installed separately or combined with a wye connector to meet any installation requirement

### Monitoring Features

- Exclusive monitoring and alarm features provide security and peace of mind for homeowners and contractors
- User-friendly audible and visual alarms notify the user that maintenance is required, ensuring the pump will operate when needed

### Pro Series Pumps CONNECT

- Remote notification available using built-in USB data port or remote terminal (PHCC-1850, PHCC-2400, PS-C22, PS-C33, PS-C50), allowing emergency and maintenance alerts to be sent via text, email, push notification, home security system, or other dry-contact device

### Good, Better, Best Selection

- Gives users and contractors a choice that satisfies every feature or budget requirement





# Battery Backup Sump Pumps



## Features

### Pro Series backup sump pumps protect against:

- Power outages
- Primary pump failures
- Float switch failures
- Excessive inflow of water

### Pro Series backup sump pumps sound an alarm when:

- AC power is out or the circuit breaker has blown
- Battery is discharged, terminals need cleaning, or pump was activated

### Pro Series backup sump pumps offer:

- 12-volt DC sump pump with decades of proven reliability
- 24-hour-a-day monitoring of battery, pump and power conditions
- Socketed dual float switches for added reliability and easy installation
- Ability to connect to external devices like Pro Series Pumps CONNECT WiFi Module or other devices (PHCC-1850, PHCC-2400)
- Optional 20-foot cord available for backup pump, controller and float switches
- Designed around the Pro Series maintenance-free battery yet compatible with other wet-cell and maintenance-free batteries



## PHCC-1000



## PHCC-1850



## PHCC-2400



## Backup System Comparison

	PHCC-1000	PHCC-1850	PHCC-2400
Pumping capacity (in gallons per hour @ 10-foot height)	1,000 GPH	1,850 GPH	2,400 GPH
<b>Efficient</b>			
Charger strength (higher Amps recharge battery faster)	.4 Amps	1.6 Amps	13 Amps
Caged dual float switch provides added protection			•
System pumps intermittently for days	•	•	•
<b>Automatic</b>			
Switches automatically to battery power if AC power fails	•	•	•
Pumps automatically when water volume exceeds the capacity of the main AC pump	•	•	•
Exercises pump weekly to extend pump life		•	•
Tests pump for proper operation			•
<b>Versatile</b>			
Pumps on AC power when available as well as battery power			•
Designed for use with maintenance-free or wet-cell batteries	•	•	•
Can handle multiple standby batteries to extend runtime		•	•
USB data port (remotely notifies of specific issues with your system using Pro Series WiFi Module)		•	•
Remote terminal (remotely notifies about general issues with your system using Pro Series WiFi Module, home security system, or other device)		•	•
<b>User-Friendly</b>			
Detects irregularities, sounds an alarm, and pinpoints problems and solutions on the control panel	•	•	•
Alarm can be silenced during a power outage	•	•	•

# Battery Backup Sump Pumps

Specifications			
	PHCC-1000	PHCC-1850	PHCC-2400
Flow @ 10-Ft GPH (3 M) Head	1,000 GPH	1,850 GPH	2,400 GPH
Amps @ 10-Ft Total Head	6.5 Amps	10-12 Amps	20 Amps
Outlet	1.5 in PVC adapter	1.5 in PVC adapter	1.5 in PVC adapter
Voltage	12 VDC	12 VDC	12 VDC
Power Input	115VAC, 60 Hz	115VAC, 60 Hz	115VAC, 60 Hz
Charger Strength Voltage/Current	12 VDC/.4 Amps	12 VDC/1.6 Amps	12 VDC/13 Amps
Motor Type	DC	DC	DC
<b>Construction</b>			
Pump Housing	Noncorrosive ABS	Noncorrosive ABS	Noncorrosive ABS
Impeller	Noncorrosive ABS	Noncorrosive ABS	Fiber-filled polycarbonate
Shaft Material	Stainless steel	Stainless steel	Stainless steel
Float Switch	Dual micro-reed	Dual micro-reed	Caged dual micro-reed
Pump Dimensions (W x D x H)	8.5 x 4.5 x 6.5 in (21.6 x 11.4 x 16.5 cm)	9.0 x 5.0 x 7.5 in (22.9 x 12.7 x 19.1 cm)	9.0 x 4.5 x 8.5 in (22.9 x 11.4 x 21.6 cm)
Controller Dimensions (W x D x H)	4.0 x 2.5 x 4.5 in (10.2 x 6.4 x 11.4 cm)	7.0 x 3.0 x 4.4 in (17.8 x 7.6 x 11.1 cm)	6.25 x 7.25 x 8.25 in (15.9 x 18.4 x 20.9 cm)
Shipping Weight	9.0 lb (4.1 kg)	12.0 lb (5.4 kg)	23.0 lb (10.4 kg)
<b>Pumping Time with Battery*</b>			
B12-100	110 hours	70 hours	55 hours
(2) B12-100	Not recommended	140 hours	110 hours

\*Runtime based on 10% duty cycle. Runtimes may vary based on water flow.

## Included with System

- 12 VDC sump pump
- Monitoring controller
- Caged dual float switch (PHCC-2400)
- Dual float switch (PHCC-1000, PHCC-1850)
- Snap-on, noncorrosive screen
- 1.5-inch pipe adapter
- Battery box

## Pump Performance

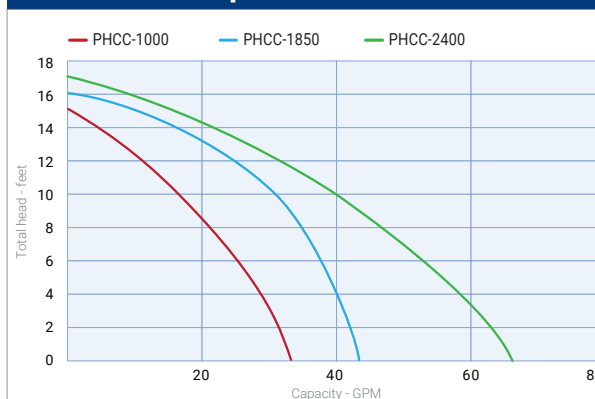

## Direct discharge outside

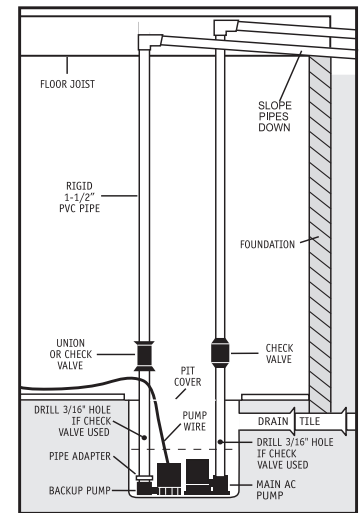

## Discharge into existing pipe

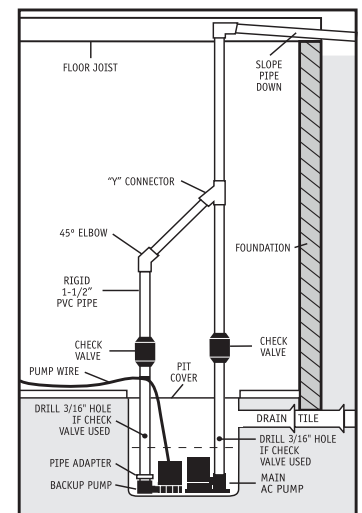

## Installation in narrow sump pit

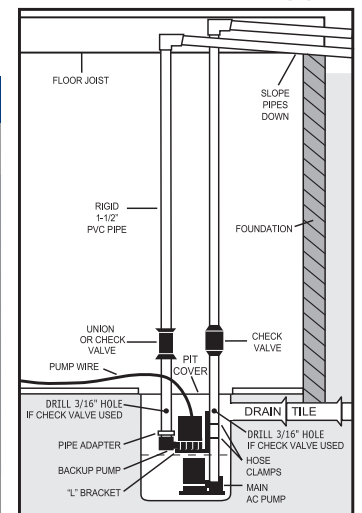



# Combination Systems



## Features

- Preassembled for quick, easy installation
- Compact—fits neatly into most sump pits
- Automatically switches to battery when AC fails
- 24-hour monitoring sounds an alarm, pinpoints problems and solutions on control panel
- Primary pump with energy-efficient PSC motor is continuous-duty rated and water cooled
- Primary pump controller can adjust pump runtime, and exercises pump to extend pump life
- Dual float switches for both primary/backup pumps provide 4 times the protection
- Backup will assist primary pump if excessive amounts of water are entering the sump pit
- Maintains/recharges battery automatically
- Alarm can be silenced during a power outage
- USB data port/remote terminals connect to external devices such as the Pro Series CONNECT Module or other devices for notification (PS-C22, PS-C33, PS-C50)
- Pumps are securely attached to raised sump foot with stainless-steel screws to prevent movement or breakage
- Float stick allows for easy adjustment of both primary and backup dual floats

### PS-C11



- **S1033 Primary**  
Pumps 2,770 GPH at 10 feet
- **PHCC-1000 Backup**  
Pumps 1,000 GPH at 10 feet

### PS-C22



- **S1033 Primary**  
Pumps 2,770 GPH at 10 feet
- **PHCC-1850 Backup**  
Pumps 1,850 GPH at 10 feet

### PS-C33/PS-C50



- **PS-C50 includes:** S3050 Primary Pumps 3,900 GPH at 10 feet
- **PS-C33 includes:** S3033 Primary Pumps 3,000 GPH at 10 feet
- **PHCC-2400 Backup**  
Pumps 2,400 GPH at 10 feet

#### Primary Pump Construction

- Permanent Split Capacitor (PSC) motor
- Upper and lower sealed ball bearings
- Cast-iron housing (PS-C11, PS-C22)
- Cast-iron/stainless-steel housing (PS-C33, PS-C50)
- Electroplated steel shaft (PS-C11, PS-C22)
- Stainless-steel shaft (PS-C33, PS-C50)
- Dual carbon ceramic shaft seals plus additional Buna N seal
- Engineered polymer impeller (PS-C11, PS-C22)
- Polycarbonate impeller (PS-C33, PS-C50)
- Stainless-steel fasteners

#### Backup Pump Construction

- Noncorrosive ABS housing
- Stainless-steel shaft and fasteners
- Rulon seal (PS-C11, PS-C22)
- Carbon ceramic seal w/ Buna N seal (PS-C33, PS-C50)
- Noncorrosive ABS impeller (PS-C11, PS-C22)
- Noncorrosive fiber-filled impeller (PS-C33, PS-C50)
- Dual ball bearings (PS-C33, PS-C50)

\* 4-year warranty is available when purchased and installed by a contractor; otherwise the original 3-year warranty is applicable.

# Combination Systems



## Included with System:

- Preassembled: primary pump, backup pump, (3) 1½" no-hub couplings, (2) standard check valves with hardware, sump foot
- Backup controller charges and monitors system
- Primary pump with enhanced controller and caged dual float switch (DFC1.5)
- Includes battery box, and float stick for adjustable float height

## Specifications

Primary Pump	PS-C11	PS-C22	PS-C33	PS-C50
Flow at 10 Ft Head	2,770 GPH	2,770 GPH	3,000 GPH	3,900 GPH
Max Head	29 ft/8.8 m	29 ft/8.8 m	30 ft/9.1 m	33 ft/10.0 m
Discharge	1½ in	1½ in	1½ in	2 in
Motor HP	⅓	⅓	⅓	½
Voltage	115V, 60Hz	115V, 60Hz	115V, 60Hz	115V, 60Hz
Amp Draw at 10 Ft	3.8	3.8	4.0	4.3
Backup Pump				
Flow at 10 Ft Head	1,000 GPH	1,850 GPH	2,400 GPH	2,400 GPH
Voltage	12 VDC	12 VDC	12 VDC	12 VDC
DC Current	6.5 Amps	10-12 Amps	20 Amps	20 Amps
Dimensions				
Width	9.75 in/24.8 cm	9.75 in/24.8 cm	9.75 in/24.8 cm	9.75 in/24.8 cm
Depth	11.0 in/27.9 cm	11.0 in/27.9 cm	11.0 in/27.9 cm	11 in/27.9 cm
Height	17.25/43.8 cm	17.25/43.8 cm	17.25/43.8 cm	17.25/43.8 cm
Weight	28.5 lb/12.9 kg	32 lb/14.5 kg	43 lb/19.5 kg	47.0 lb/21.3 kg

## Backup Pump Monitoring

Will sound alarm indicating:	PS-C11	PS-C22	PS-C33	PS-C50
Battery is old and needs to be replaced	•	•	•	•
Battery is discharged	•	•	•	•
Cable is loose or terminals are corroded	•	•	•	•
Power, fuse or circuit breaker has failed	•	•	•	•
Pump activated; check main pump for failure	•	•	•	•
Remote notification ability*		•	•	•
Exercises pump weekly to extend pump life		•	•	•
Tests health of the pump weekly			•	•
Backup pump runs off AC and battery power			•	•
Displays percentage of power			•	•

## Exclusive Float Stick

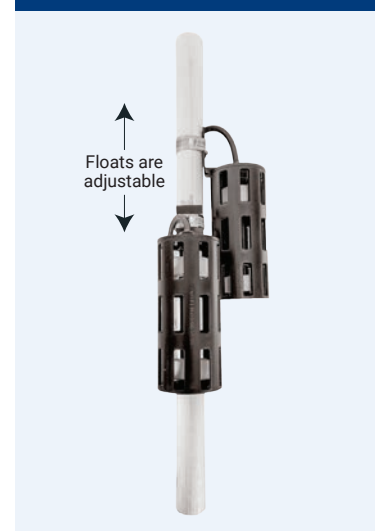

\*USB data port/remote terminals connect to external devices such as the Pro Series CONNECT Module or other devices for notification



# Accessories

## Standby Battery

### Pro Series Standby Battery is designed to:

- Run the pump longer and for more hours per charge
- Last longer in standby operation
- Work with all backup and combination systems
- Pro Series backup systems are designed around the Pro Series Standby Battery for guaranteed compatibility

### Maintenance-Free AGM Standby Battery

- Provides dependable service without having to add distilled water
- Needs no acid to activate

Pumping Time	Maintenance-Free Battery	
System	B12-100	(2) B12-100 with PJC
PHCC-1000	110 hours*	Not recommended
PHCC-1850	70 hours*	140 hours*
PHCC-2400	55 hours*	110 hours*

\*Based on 10% duty cycle. Runtimes may vary based on inflow of water.

### Specifications

Height (Top of Post)	9 $\frac{7}{8}$ in
Length	12 in
Width	6 $\frac{1}{2}$ in
Voltage	12 VDC
Shipping Weight	57 lb
Case Size	31
Amp hours	100



B12-100

### Battery Accessories | Parallel Jumper Cable

- Parallel Jumper Cable connects multiple Pro Series batteries to extend runtime
- PS-C22, PS-C33, PS-C50 combination systems
- PHCC-1850, PHCC-2400 battery backups
- 12-gauge wires, 40-inch length with  $\frac{3}{8}$ -inch and  $\frac{5}{16}$ -inch ring terminals



PJC

## Pit Cleaner

### Clenit™ does the work for you!

- Removes iron ochre—the red slime buildup—and other deposits from your sump pit
- Helps maintain a healthy pump and pit
- Great for periodic pit maintenance

Simply pour Clenit™ into your sump system, allow the proprietary powder to attack the iron ochre, and have your pump evacuate the pit. Since Clenit™ is made from a naturally occurring compound, it is 100% biodegradable and safe for the environment.



# Clenit™

CLEANSSES IRON OCHRE IN SUMP PITS



CL7

# Accessories

## Sump Foot

### 2 STYLES AVAILABLE

#### Key Features

- Keeps pump out of dirt and debris and prevents it from clogging
- Predrilled holes for ease of installation
- Made of high-impact polypropylene
- Includes mounting hardware
- 1-year warranty



**SF1A**

- Provides solid base for a single pump, either backup or primary pump

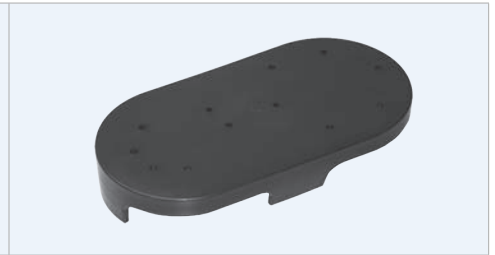

**SF2A**

- Provides solid base for both backup and primary pump

## Cord Management Box



PS-MB994

### MINIMIZE YOUR TANGLED MESS OF CORDS!

- Indoor and outdoor use
- Great way to identify "installed by" and "model"
- Cord gasket and mounting hardware included
- Door can open 180°
- Built-in latch keeps enclosure closed
- Flexible mounting options

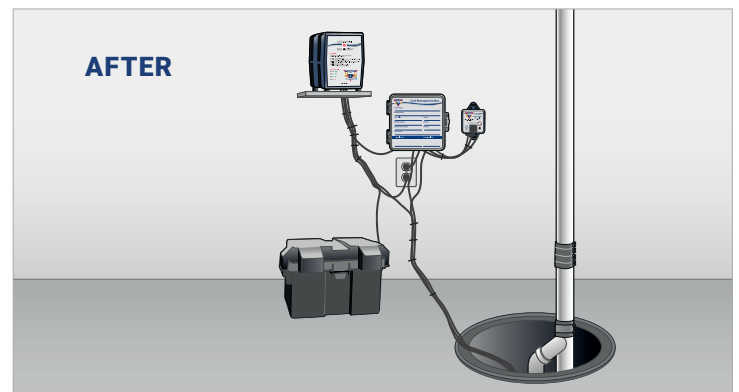

## Water Sensor

HIGH WATER  
ACCESSORY  
(PS-WS)

### For use in sump or sewage pits

- Paired with the Deluxe Controller (TSC2, VSC2, DFC2), will activate a warning light, an audible alarm, and send a signal to the remote terminal
- Paired with the Water Alarm (PWA2), will sound a 110 dB alarm
- Mounting hardware included—10-foot cord with 3.5mm plug
- Attaches to discharge pipe

PS-WS





# Water Alarms

## Water Alarms and Optional Accessories

### ACCIDENTS HAPPEN...

PWA2, PWA-360

Place a water alarm where water damage is a risk:

- Washing machines overflow
- Laundry tubs clog, spill over
- Water heaters leak
- Water pipes break

### Dependable protection

- Solid-state circuitry is extremely sensitive and reliable
- 110 dB alarm can be heard throughout the house

### Extended life

- Alarm will sound up to 3 days
- Up to 5 years of protection on a new alkaline battery (dependent on age of battery)

### Easy to use

- Install a 9V alkaline battery (not included), place the alarm on the floor, or hang the alarm and extend the sensor to the floor or into the sump pit



### Standalone Water Alarm

PWA2

Built-in accessory jack for optional, add-on accessories



### AVAILABLE ADD-ON ACCESSORIES:

#### 20-Foot Extension

EXT-PWA20

For use with 360° Water Sensor (PS-WS360) and Water Sensor (PS-WS)

#### Water Sensor

PS-WS

Place in a sump or sewage pit (more information on page 23)

#### 360° Water Sensor

PS-WS360

Patented 360° sensing technology detects water when placed on side, top or bottom



### 360° Water Alarm

PWA-360

- Place a water alarm wherever there is a risk of water damage
- Patented 360° sensing technology will detect water when placed on any side, top or bottom
- Easy-to-use, dependable protection



Example of multiple 360° Water Sensors connected to one water alarm

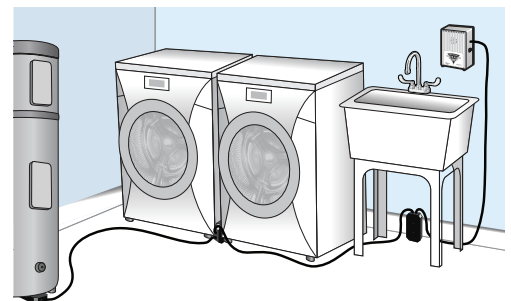



# Check Valves

Categories	
Model	Description
<b>Booted Check Valves</b>	
PS-CCV1	1½" Klunkless (Quiet) Check Valve with Silencing Air Chamber and 1½"/1¼" Rubber Unions
PS-CVRRU15	1½" Check Valve with Two Rubber Unions
PS-CVKSRRU15	1½" PVC Klunkless (Quiet) Check Valve with Two Rubber Unions
PS-CVKSRRU20	2" PVC Klunkless (Quiet) Check Valve with Two Rubber Unions
<b>Threaded Check Valves</b>	
PS-CVW125	1¼" Threaded Check Valve and 1½" On Top with Weep Hole and No Couplings
PS-CVW15	1½" Threaded Check Valve with Weep Hole, No Couplings
PS-CVWRU	1½" Threaded Check Valve with Weep Hole and Rubber Union
PS-CVWNH	1½" Threaded Check Valve with Weep Hole and No-Hub Coupling
<b>Slip Check Valves</b>	
PS-CVS15	1½" PVC Check Valve with Slip Connections
PS-CVS20	2" PVC Check Valve with Slip Connections
PS-CVKS15	1½" PVC Klunkless (Quiet) Check Valve with Slip Connections
PS-CVKS20	2" PVC Klunkless (Quiet) Check Valve with Slip Connections
<b>Slip Union Check Valves</b>	
PS-CVSU15	1½" PVC Check Valve with Slip Union Connections
PS-CVSU20	2" PVC Check Valve with Slip Union Connections
PS-CVKSU15	1½" PVC Klunkless (Quiet) Check Valve with Slip Union Connections
PS-CVKSU20	2" PVC Klunkless (Quiet) Check Valve with Slip Union Connections
PS-CVBVSU20	2" PVC Check Valve and Ball Valve with Slip Union Connections
PS-CVKBVSU20	2" PVC Klunkless (Quiet) Check Valve and Ball Valve with Slip Union Connections
<b>Compression Check Valves</b>	
PS-CVC15	1½" PVC Check Valve with Compression Connections
PS-CVC20	2" PVC Check Valve with Compression Connections
PS-CVKC15	1½" PVC Klunkless (Quiet) Check Valve with Compression Connections
PS-CVKC20	2" PVC Klunkless (Quiet) Check Valve with Compression Connections
PS-CVBVC20	2" PVC Check Valve and Ball Valve with Compression Connections
PS-CVKBVC20	2" PVC Klunkless (Quiet) Check Valve and Ball Valve with Compression Connections
<b>Ball Valves</b>	
PS-BVS15	1½" PVC Ball Valve
PS-BVS20	2" PVC Ball Valve
<b>KEY:</b>	CV–Check Valve, K–Klunkless (Quiet), S–Slip, C–Compression, SU–Slip Union, RU–Rubber Union, W–Weep Hole, BV–Ball Valve



Slip Connection



Slip Union Connection



Rubber Booted (Quiet) Check Valve



Compression Connection



Threaded Connection



Ball Valve

## Quick Connect Main Pipe

### Makes Sump Pump Replacement and Installation Easy

- No need to remove the pipe from the old pump
- Save time—no need to cut, drill, prime and glue PVC
- Save on cost of adapters, PVC, primer and cement

### PS-MP

Total length: 14.25"

### Preassembled with:

1. 1½" rubber union
1. 1½" check valve
1. 1½" NPT female adapter
1. Predrilled weep hole
1. 1½" discharge pipe
1. 1½" NPT threaded male adapter



(800) 991-0466





# Choosing the Right Pump

## What Does Your Customer Need or Want

### My customer is looking for a quality primary sump pump

1 Choose based on pump's housing material, or length of warranty	2 Then select the HP based on capacity <small>(see <i>What size pump do I need?</i> page 27)</small>	3 Now, select the style switch you prefer	4 Lastly, select the features you or your customers prefer for the controller
<p><b>Housing materials</b></p> <ul style="list-style-type: none"> <li>• Cast-iron/cast-aluminum—ST Series Pumps</li> <li>• Cast-iron—S1/S2 Series Pumps</li> <li>• Cast-iron/stainless-steel—S3 Series Pumps</li> </ul> <p><b>Our Warranties</b> </p> <ul style="list-style-type: none"> <li>• 3 year—S1/ST Series Pumps</li> <li>• 4 year—S2 Series Pumps</li> <li>• 5 Year—S3 Series Pumps</li> </ul> <p><small>(when purchased and installed by a pro contractor)</small></p>	<ul style="list-style-type: none"> <li>• S1/ST Series: ½ HP 2,770 GPH/46 GPM @10' ½ HP 4,320 GPH/72 GPM @10'</li> <li>• S2 Series: ½ HP 3,200 GPH/53 GPM @10' ½ HP 3,840 GPH/64 GPM @10'</li> <li>• S3 Series: ½ HP 3,000 GPH/50 GPM @10' ½ HP 3,900 GPH/65 GPM @10' 1 HP 5,520 GPH/92 GPM @10'</li> </ul>	<ul style="list-style-type: none"> <li>• Tether Switch</li> <li>• Vertical Switch—great for sump or sewage</li> <li>• Caged Dual Float—<b>most reliable</b> in the industry</li> </ul>	<ul style="list-style-type: none"> <li>• Standard controller</li> <li>• Enhanced controller—exercises the pump weekly &amp; adjustable runtime</li> <li>• Deluxe controller—above features plus monitors pump and power conditions giving visual, audible and optional remote notifications</li> <li>• High Cycle—great for high cycle applications</li> </ul>

### My customer has an older or failed primary pump and would like protection with a backup

1 Choose based on the HP (the capacity needed) of the primary pump	2 If you <u>don't</u> need a ½ HP sump, decide which level of backup protection fits your customer best			
½ HP primary—PS-C50 ⅓ HP primary—PS-C11, PS-C22, PS-C33	All combo pumps monitor the battery, pump and power conditions with a visual light and audible alarm and have a primary pump with a high-capacity PSC motor	PS-C11	PS-C22	PS-C33
		<ul style="list-style-type: none"> <li>• 1,000 GPH</li> <li>• .4 Amp charger</li> </ul>	<ul style="list-style-type: none"> <li>• 1,850 GPH</li> <li>• 1.6 Amp charger</li> <li>• Exercises the backup weekly</li> <li>• Optional remote notification</li> </ul>	<ul style="list-style-type: none"> <li>• 2,400 GPH</li> <li>• 13 Amp charger</li> <li>• Tests and exercises the backup weekly</li> <li>• Optional remote notification</li> <li>• Battery power display</li> <li>• Runs backup off AC or DC power</li> </ul>

### My customer has a newer primary pump and is just looking to provide backup protection

All backup pumps monitor the battery, pump and power conditions with a visual light and audible alarm	Pro Series 1000	Pro Series 1850	Pro Series 2400
	<ul style="list-style-type: none"> <li>• 1,000 GPH</li> <li>• .4 Amp charger</li> </ul>	<ul style="list-style-type: none"> <li>• 1,850 GPH</li> <li>• 1.6 Amp charger</li> <li>• Exercises the backup weekly</li> <li>• Optional remote notification</li> </ul>	<ul style="list-style-type: none"> <li>• 2,400 GPH</li> <li>• 13 Amp charger</li> <li>• Tests the backup weekly</li> <li>• Optional remote notification</li> <li>• Battery power display</li> <li>• Runs backup off AC or DC power</li> </ul>

# Choosing the Right Pump

## What size pump do I need?

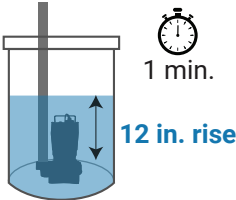
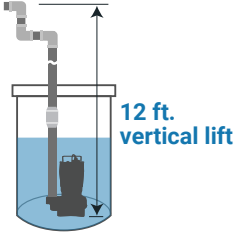
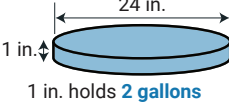
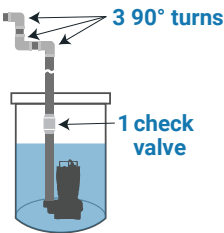
1 Determine how much capacity you need	2 Determine how much strength you need (estimated total dynamic head)											
<p><b>Step 1 -</b></p> <ul style="list-style-type: none"> <li>On a very wet, rainy day, run the sump pump until the water recedes to the shutoff level</li> <li>Put a tape measure into the pit. Wait for 1 minute with the pump off, and measure how many inches the water level rises</li> <li>Remember this number</li> </ul> 	<p><b>Step 1 - Figure out your fixed vertical lift</b></p> <ul style="list-style-type: none"> <li>Measure the vertical distance from the bottom of the pit to the highest point in the discharge line</li> </ul> <p>This is the fixed vertical lift</p> 											
<p><b>Step 2 -</b></p> <ul style="list-style-type: none"> <li>Take how many inches the water rose, from Step 1, and multiply by how many gallons per vertical inch the pit holds</li> </ul> <table border="1" data-bbox="138 793 479 919"> <tr> <td>12 in. diameter pit</td> <td>½ gallon per vertical in.</td> </tr> <tr> <td>18 in. diameter pit</td> <td>1 gallon per vertical in.</td> </tr> <tr> <td>24 in. diameter pit</td> <td>2 gallons per vertical in.</td> </tr> <tr> <td>30 in. diameter pit</td> <td>3 gallons per vertical in.</td> </tr> </table>  <p><b>(12 in. rise x 2 gal per vertical in. = 24 gallons)</b></p>	12 in. diameter pit	½ gallon per vertical in.	18 in. diameter pit	1 gallon per vertical in.	24 in. diameter pit	2 gallons per vertical in.	30 in. diameter pit	3 gallons per vertical in.	<p><b>Step 2 - Determine extra head pressure</b></p> <ul style="list-style-type: none"> <li>Check valves and turns in the discharge pipe add head pressure to your pump</li> </ul> <table border="1" data-bbox="852 793 1193 924"> <tr> <td>A 90° turn = 1 extra foot of head pressure</td> </tr> <tr> <td>Check valve = 1 extra foot of head pressure</td> </tr> <tr> <td>Every 20 feet of horizontal pipe that holds water (does not drain naturally) = 1 extra foot of head pressure</td> </tr> </table>  <p><b>[3 (90° turns) + 1 (check valve) = 4 extra ft. of head pressure]</b></p>	A 90° turn = 1 extra foot of head pressure	Check valve = 1 extra foot of head pressure	Every 20 feet of horizontal pipe that holds water (does not drain naturally) = 1 extra foot of head pressure
12 in. diameter pit	½ gallon per vertical in.											
18 in. diameter pit	1 gallon per vertical in.											
24 in. diameter pit	2 gallons per vertical in.											
30 in. diameter pit	3 gallons per vertical in.											
A 90° turn = 1 extra foot of head pressure												
Check valve = 1 extra foot of head pressure												
Every 20 feet of horizontal pipe that holds water (does not drain naturally) = 1 extra foot of head pressure												
<p><b>Step 3 -</b></p> <ul style="list-style-type: none"> <li>Multiply the number of gallons (from Step 2) by 60, in order to estimate the volume of water that would come into the pit during an hour of steady rain</li> </ul> <p><b>[24 gallons x 60 minutes = 1,440 GPH (gallons per hour)]</b></p>	<p><b>Step 3 -</b></p> <ul style="list-style-type: none"> <li>Add your fixed vertical lift, from step 1, to your extra feet of head pressure, from step 2, to get your total dynamic head</li> </ul> <p><b>[12 ft. (vertical lift) + 4 ft. (extra head pressure) = 16 ft. of head ]</b></p>											
<p><b>Step 4 -</b></p> <ul style="list-style-type: none"> <li>Industry standard is to prepare for "worst case scenario" so multiply this number by a "security factor" of 1.5</li> </ul> <p><b>(1,440 x 1.5 = 2,160 GPH)</b></p>	<p><b>The number calculated above is your total head pressure in feet. Look at the selected pump's performance curve to ensure the pump, at that head pressure, can handle the capacity needed (determined at left).</b></p>											
<p><b>You need a pump that can move 2,160 GPH</b></p>												

## Solution Finder

Sump Pumps:	Backup Sump Pumps:	Sewage Pumps:
<ul style="list-style-type: none"> <li>Pump that can handle some small solids: See S2 Series sump/effluent pumps (page 8)</li> <li>Pump with a 20-foot cord: Optional on S1, S2 and S3 Series ⅓ HP and standard on ST and S3 ½ HP (page 8)</li> <li>Pump that can send a message if an issue arises: See Deluxe and High-Cycle Controllers (page 15), which are compatible with all -NS pumps (page 8)</li> <li>Pump that will handle high-cycle (lots of on-and-off) applications: See C3 Controller (page 15) or Pump Alternator (page 16) with an S3 Series or E7 Series pump</li> </ul>	<ul style="list-style-type: none"> <li>Quick, easy install: See preassembled combo units (pages 20-21)</li> <li>A ½ HP combo unit: See PS-C50 (page 20)</li> <li>Capable of remote notification: See 1850 and 2400 (page 18) or PS-C22, PS-C33 and PS-C50 (page 20)</li> <li>Can increase runtime to cover longer power outages: See Parallel Jumper Cable (page 22)</li> </ul>	<ul style="list-style-type: none"> <li>Backup protection for my sewage pit: See Pump Alternator (page 16)</li> <li>Lights and alarms for my sewage pit: See TSC2 and VSC2 (pages 14-15) or DVSA-VS and DVSA (page 16)</li> <li>Remote notification: See TSC2 and VSC2 (pages 14-15) or DVSA-VS and DVSA (page 16)</li> <li>High water float for additional protection: See TSC2 or VSC2 (pages 14-15)</li> </ul>

# Mission Statement



Glentronics, Inc., manufacturer of Pro Series Pumps, is a family-run business whose goal is to take care of every customer like they are family. Our mission has always been to create leading-edge pumps and accessories, accomplished by our dedication to quality and our innovative engineering. We focus on what we do best, allowing us to lead the way in battery backup sump pumps, AC sump pumps, sewage pumps and combination pumps.

## Our Team



The Pro Series Pumps brand was created so professionals could offer their customers industrial-grade products for the residential market. We listen to our customers, continually adapting and improving our products to best serve their needs. We lead the market in creating energy-efficient pumps, which incorporate the most current technology.



[StopFlooding.com](http://StopFlooding.com)

### Glentronics, Inc.

645 Heathrow Dr. | Lincolnshire, IL 60069  
(800) 991-0466 | [www.StopFlooding.com](http://www.StopFlooding.com)  
[Service@glentronics.com](mailto:Service@glentronics.com)

As we are continuously improving our products, the items supplied may not agree in all details with the descriptions and specifications shown. We make every effort to provide our customers with superior products; however, Glentronics, Inc. reserves the right to change or discontinue any product without prior notice.